

# **TOSHIBA**

TOSHIBA Barcode Printer

## **B-EX6T SERIES**



**Owner's Manual**

**Mode d'emploi**

**Bedienungsanleitung**

**Manual de instrucciones**

**Gebruikershandleiding**

**Manuale Utente**

**Manual do Utilizador**

# **TOSHIBA**

TOSHIBA Barcode Printer

## **B-EX6T SERIES**

**Owner's Manual**

**CE Compliance (for EU only)**

This product complies with the requirements of EMC and Low Voltage Directives including their amendments. CE marking is the responsibility of TOSHIBA TEC GERMANY IMAGING SYSTEMS GmbH, Carl-Schurz-Str. 7, 41460 Neuss, Germany.

For a copy of the related CE Declaration of Conformity, please contact your dealer or TOSHIBA TEC.

This is a Class A product. In a domestic environment this product may cause radio interference in which case the user may be required to take adequate measures.

**VORSICHT:**

- *Schallemission: unter 70dB (A) nach DIN 45635 (oder ISO 7779)*
- *Die für das Gerät vorgesehene Steckdose muß in der Nähe des Gerätes und leicht zugänglich sein.*

Centronics is a registered trademark of Centronics Data Computer Corp.

Microsoft is a registered trademark of Microsoft Corporation.

Windows is a trademark of Microsoft Corporation.

**FCC Notice**

This equipment has been tested and found to comply with the limits for a Class A digital device, pursuant to Part 15 of the FCC Rules. These limits are designed to provide reasonable protection against harmful interference when the equipment is operated in a commercial environment. This equipment generates, uses, and can radiate radio frequency energy and, if not installed and used in accordance with the instruction manual, may cause harmful interference to radio communications. Operations of this equipment in a residential area is likely to cause harmful interference in which case the user will be required to correct the interference at his own expense.

**WARNING**

Changes or modifications not expressly approved by the party responsible for compliance could void the user's authority to operate the equipment.

(for USA only)

**CAN ICES-3 (A) / NMB-3 (A)**

This Class A digital apparatus complies with Canadian ICES-003.

(for CANADA only)

**California Proposition 65 Warning: USA-California only**

This Product contains chemicals known to the State of California to cause cancer, birth defects, or other reproductive harm.

Changes or modifications not expressly approved by the manufacturer for compliance could void the user's authority to operate the equipment.

**This product is designed for commercial usage and is not consumer product.**

**The following information is for EU-member states only:**

**Disposal of products**

**(based on EU-Directive 2002/96/EC,**

**Directive on Waste electrical and electronic equipment – WEEE)**



The use of the symbol indicates that this product may not be disposed as unsorted municipal waste and has to be collected separately. Integrated batteries and accumulators can be disposed of with the product. They will be separated at the recycling centers.

The black bar indicates that the product was placed on the market after August 13, 2005.

By ensuring this product is disposed of correctly, you will help prevent potential negative consequences for the environmental and human health, which could otherwise be caused by inappropriate waste handling of this product.

For more detailed information about the take-back and recycling of this product, please contact your supplier where you purchased this product.

**Notification (for Turkey)**

AEEE Yönetmeliğine Uygundur

**Following information is only for India:**



The use of the symbol indicates that this product may not be treated as household waste. By ensuring this product is disposed of correctly, you will help prevent potential negative consequences for the environment and human health, which could otherwise be caused by inappropriate waste handling of this product.

For more detailed information about the take-back and recycling of this product, please contact your supplier where you purchased the product.

This product complies with the "India E-waste Rule 2011" and prohibits use of lead, mercury, hexavalent chromium, polybrominated biphenyls or polybrominated diphenyl ethers in concentrations exceeding 0.1% by weight and 0.01% by weight for cadmium, except for the exemption set in Schedule II of the Rule.

## **Precautions for the handling of Wireless Communication Devices**

**Wireless LAN Module: GS2100MIP(B-EX706-WLAN2-QM-R and B-EX6T1-GS/TS16-CN-R)**

**RFID Module: TRW-USM-10 (B-EX706-RFID-U4-US-R, B-EX6T1-GS18/TS18-CN-R), TRW-EUM-10 (B-EX706-RFID-U4-EU-R), TRW-AUM-10 (B-EX706-RFID-U4-AU-R)**

### **For Europe**

This device was tested and certified by Notified Body.

Hereby, Toshiba TEC Corporation declares that this device is in compliance with the essential requirements and other relevant provisions of Directive 1999/5/EC.

This equipment uses the radio frequency band which has not been standardized throughout the EU and EFTA countries. It can be used in the following countries.

Austria, Belgium, Bulgaria, Cyprus, Czech Republic, Denmark, Estonia, Finland, France, Hungary, Germany, Greece, Ireland, Italy, Latvia, Lithuania, Luxembourg, Malta, Netherlands, Poland, Portugal, Romania, Slovakia, Slovenia, Spain, Sweden, United Kingdom, Norway, Liechtenstein, Iceland, Switzerland

### **For USA**

This device complies with Part 15 of the FCC Rules.

Operation is subject to the following two conditions:

- (1) This device may not cause harmful interference, and
- (2) This device must accept any interference received, including interference that may cause undesired operation.

Changes or modification not expressly approved by manufacturer for compliance could void the user's authority to operate the equipment.

### **For Canada**

Operation is subject to the following two conditions:

- (1) This device may not cause interference, and
- (2) This device must accept any interference, including interference that may cause undesired operation of the device.

### **For Taiwan**

#### **Caution**

根據低功率電波輻射性電機管理辦法

### **For safety**

Do not operate this product in locations where its use may be prohibited. For example, in an aeroplane or hospital. If you are unsure whether operation is permitted, please refer to and follow the airline company or medical institution guidelines.

Otherwise, flight instrument or medical equipment may be affected, causing a serious accident.

This product may affect the operation of some implanted cardiac pacemakers and other medically implanted equipment. Pacemaker patients should be aware that the use of this product in close proximity to a pacemaker might cause the device to malfunction.

If you have any reason to suspect that interference is taking place, immediately turn off the product and contact your TOSHIBA TEC sales agent.

Do not disassemble, modify, or repair the product as doing so may cause injury.

Modification is also against the Laws and Regulations for Radio Equipment. Please ask your TOSHIBA TEC sales agent for repair.

## Safety Summary

Personal safety in handling or maintaining the equipment is extremely important. Warnings and Cautions necessary for safe handling are included in this manual. All warnings and cautions contained in this manual should be read and understood before handling or maintaining the equipment.

Do not attempt to effect repairs or modifications to this equipment. If a fault occurs that cannot be rectified using the procedures described in this manual, turn off the power, unplug the machine, and then contact your authorised TOSHIBA TEC representative for assistance.

### Meanings of Each Symbol



This symbol indicates warning items (including cautions). Specific warning contents are drawn inside the  $\Delta$  symbol. (The symbol on the left indicates a general caution.)



This symbol indicates prohibited actions (prohibited items). Specific prohibited contents are drawn inside or near the  $\text{\textcircled{/}}$  symbol. (The symbol on the left indicates “no disassembling”.)



This symbol indicates actions which must be performed. Specific instructions are drawn inside or near the  $\bullet$  symbol. (The symbol on the left indicates “disconnect the power cord plug from the outlet”.)



### WARNING

This indicates that there is the risk of **death** or **serious injury** if the machine is improperly handled contrary to this indication.



#### Use only specified AC voltage.

Do not use voltages other than the AC voltage specified on the rating plate, as this may cause **fire** or **electric shock**.

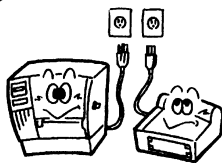

#### Prohibited

Do not plug in or unplug the power cord with wet hands as this may cause **electric shock**.

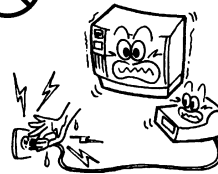

#### Prohibited

If the machine shares the same electrical outlet, with any other appliance that consumes a large amount of power, the voltage will fluctuate widely each time these appliances operate. Be sure to provide an exclusive outlet for the machine as this may cause **fire** or **electric shock**.



#### Prohibited

Do not place metal objects or water-filled containers (flower vases, flower pots or mugs etc) on top of the machine. If metal objects or spilled liquids enter the machine, this may cause **fire** or **electric shock**.

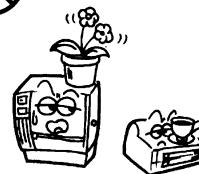

#### Prohibited

Do not insert or drop metal, flammable or other foreign objects into the machine through ventilation slits, as this may cause **fire** or **electric shock**.

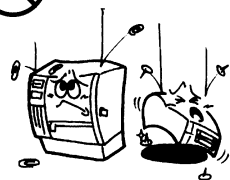

#### Prohibited

Do not scratch, damage or modify the power cords. Do not place heavy objects on, pull on, or excessively bend the power cords, as this may cause **fire** or **electrical shock**.



#### Disconnect the plug.



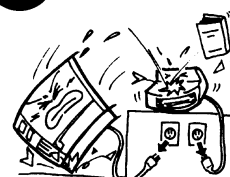







If the machine is dropped or the cabinet is damaged, turn off the power switch and disconnect the power cord plug from the outlet, and then contact your authorised TOSHIBA TEC representative for assistance. Continued use of a damaged machine may cause **fire** or **electric shock**.

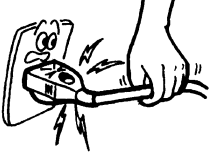

#### Disconnect the plug.

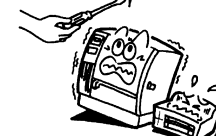
Continued use of the machine in an abnormal condition (the machine is producing smoke or a strange smell) may cause **fire** or **electric shock**. In these cases, immediately turn off the power switch and disconnect the power cord plug from the outlet. Then, contact your authorised TOSHIBA TEC representative for assistance.



 <p><b>Disconnect the plug.</b></p> 	<p>If foreign objects (metal fragments, water, liquids) enter the machine, turn off the power switch and disconnect the power cord plug from the outlet, and then contact your authorised TOSHIBA TEC representative for assistance. Continued use of the machine in that condition may cause <b>fire</b> or <b>electric shock</b>.</p>	 <p><b>Disconnect the plug.</b></p> 	<p>When unplugging the power cords, be sure to hold and pull on the plug. Pulling on the cord may cut or expose the internal wires and cause <b>fire</b> or <b>electric shock</b>.</p>
 <p><b>Connect a grounding wire.</b></p> 	<p>Ensure that the equipment is properly grounded. Extension cables should also be grounded. <b>Fire</b> or <b>electric shock</b> could occur on improperly grounded equipment.</p>	 <p><b>No disassembling.</b></p> 	<p>Do not remove covers, repair or modify the machine yourself. Contact your TOSHIBA TEC representative for assistance. You may be <b>injured</b> by high voltage, very hot parts or sharp edges inside the machine.</p>
 <p><b>Prohibited</b></p> 	<p>Do not use a spray cleaner containing flammable gas for cleaning this product, as this may cause a <b>fire</b>.</p>	 <p><b>Prohibited</b></p> 	<p>Care must be taken not to injure yourself with the printer paper cutter.</p>



**CAUTION**

This indicates that there is the risk of personal **injury** or **damage** to objects if the machine is improperly handled contrary to this indication.

**Precautions**

The following precautions will help to ensure that this machine will continue to function correctly.

- Try to avoid locations that have the following adverse conditions:
  - \* Temperatures out of the specification
  - \* Shared power source
  - \* Direct sunlight
  - \* Excessive vibration
  - \* High humidity
  - \* Dust/Gas
- The cover should be cleaned by wiping with a dry cloth or a cloth slightly dampened with a mild detergent solution. **NEVER USE THINNER OR ANY OTHER VOLATILE SOLVENT** on the plastic covers.
- **USE ONLY TOSHIBA TEC SPECIFIED** paper and ribbons.
- **DO NOT STORE** the paper or ribbons where they might be exposed to direct sunlight, high temperatures, high humidity, dust, or gas.
- Ensure the printer is operated on a level surface.
- Any data stored in the memory of the printer could be lost during a printer fault.
- Try to avoid using this equipment on the same power supply as high voltage equipment or equipment likely to cause mains interference.
- Unplug the machine whenever you are working inside it or cleaning it.
- Keep your work environment static free.
- Do not place heavy objects on top of the machine, as these items may become unbalanced and fall causing **injury**.
- Do not block the ventilation slits of the machine, as this will cause heat to build up inside the machine and may cause **fire**.
- Do not lean against the machine. It may fall on you and could cause **injury**.
- Unplug the machine when it is not used for a long period of time.
- Place the machine on a stable and level surface.
- **RISK OF EXPLOSION IF BATTERY IS REPLACED BY AN INCORRECT TYPE. DISPOSE OF USED BATTERIES ACCORDING TO THE INSTRUCTIONS.**

**Request Regarding Maintenance**

- Utilize our maintenance services.  
After purchasing the machine, contact your authorized TOSHIBA TEC representative for assistance once a year to have the inside of the machine cleaned. Dust will build up inside the machines and may cause a **fire** or a **malfunction**. Cleaning is particularly effective before humid rainy seasons.
- Our preventive maintenance service performs periodic checks and other work required to maintain the quality and performance of the machine.  
For details, please consult your authorized TOSHIBA TEC representative.
- Do not expose the machine to insecticides or other volatile solvents. This may cause the cabinet, or other parts, to deteriorate and may cause the paint to peel.

## TABLE OF CONTENTS

	Page
<b>1. PRODUCT OVERVIEW.....</b>	<b>E1- 1</b>
1.1 Introduction.....	E1- 1
1.2 Features .....	E1- 1
1.3 Unpacking.....	E1- 1
1.4 Accessories .....	E1- 2
1.5 Appearance .....	E1- 3
1.5.1 Dimensions .....	E1- 3
1.5.2 Front View .....	E1- 3
1.5.3 Rear View .....	E1- 3
1.5.4 Operation Panel.....	E1- 4
1.5.5 Interior .....	E1- 4
1.6 Options .....	E1- 5
<b>2. PRINTER SETUP .....</b>	<b>E2- 1</b>
2.1 Installation .....	E2- 2
2.2 Connecting the Power Cord .....	E2- 3
2.3 Loading Supplies .....	E2- 4
2.3.1 Loading the Media .....	E2- 5
2.3.2 Loading the Ribbon.....	E2-10
2.4 Connecting the Cables to Your Printer .....	E2-12
2.5 Turning the Printer ON/OFF .....	E2-13
2.5.1 Turning ON the Printer.....	E2-13
2.5.2 Turning OFF the Printer .....	E2-13
2.6 Printer Setting.....	E2-14
2.6.1 Scope.....	E2-14
2.6.2 Outline.....	E2-14
2.6.3 Operation panel .....	E2-14
2.6.4 Outline of each Mode.....	E2-15
2.6.5 General View of Key Operation .....	E2-16
2.6.6 Initial Setting Wizard .....	E2-18
2.7 Printer Drivers.....	E2-21
2.8 Print Test .....	E2-23
<b>3. ONLINE MODE.....</b>	<b>E3- 1</b>
3.1 Key Functions.....	E3- 1
3.2 LCD .....	E3- 2
3.3 Icon.....	E3- 3
3.4 Operation Example .....	E3- 4
3.5 User System Mode .....	E3- 7
3.5.1 Outline of use system mode .....	E3-7
3.5.2 Exit.....	E3-7
3.6 Power Save Function .....	E3-8
3.6.1 Entering the Power Saving Mode.....	E3-8
3.6.2 Exiting the Power Saving Mode .....	E3-8
<b>4. MAINTENANCE .....</b>	<b>E4- 1</b>
4.1 Cleaning .....	E4- 1
4.1.1 Print Head/Platen/Sensors.....	E4- 1
4.1.2 Covers and Panels.....	E4- 2
4.1.3 Optional Cutter Module .....	E4- 3
<b>5. TROUBLESHOOTING .....</b>	<b>E5- 1</b>



5.1	Error Messages .....	E5- 1
5.2	Possible Problems .....	E5- 4
5.3	Removing Jammed Media .....	E5- 5
<b>6.</b>	<b>PRINTER SPECIFICATIONS .....</b>	<b>E6- 1</b>
<b>7.</b>	<b>SUPPLY SPECIFICATIONS .....</b>	<b>E7- 1</b>
7.1	Media .....	E7- 1
7.1.1	Media Type .....	E7- 1
7.1.2	Detection Area of the Transmissive Sensor .....	E7- 3
7.1.3	Detection Area of the Reflective Sensor .....	E7- 4
7.1.4	Effective Print Area of Paper .....	E7- 5
7.2	Ribbon .....	E7- 6
7.3	Recommended Media and Ribbon Types .....	E7- 6
7.4	Care/Handling of Media and Ribbon .....	E7- 7
<b>APPENDIX 1 MESSAGES AND LEDS .....</b>		<b>EA1-1</b>
<b>APPENDIX 2 INTERFACE .....</b>		<b>EA2-1</b>
<b>APPENDIX 3 PRINT SAMPLES .....</b>		<b>EA3-1</b>
<b>APPENDIX 4 GLOSSARIES .....</b>		<b>EA4-1</b>

**WARNING!**

*This is a Class A product. In a domestic environment this product may cause radio interference in which case the user may be required to take adequate measures.*

**CAUTION!**

1. *This manual may not be copied in whole or in part without prior written permission of TOSHIBA TEC.*
2. *The contents of this manual may be changed without notification.*
3. *Please refer to your local Authorised Service representative with regard to any queries you may have in this manual.*

# 1. PRODUCT OVERVIEW

## 1.1 Introduction

Thank you for choosing the TOSHIBA B-EX6T series bar code printer. This Owner's Manual contains from general set-up through to how to confirm the printer operation using a test print, and should be read carefully to help gain maximum performance and life from your printer. For most queries please refer to this manual and keep it safe for future reference. Please contact your TOSHIBA TEC representative for further information concerning this manual.

## 1.2 Features

This printer has the following features:

- The print head block can be opened enabling easy loading of media and ribbon.
- Various types of media can be used as the media sensors can be moved from the centre to the left edge of the media.
- Web based functions such as remote maintenance and other advanced network features are available.
- Superior hardware, including the specially developed 8 dots/mm (203 dots/inch) or 12 dots/mm (305 dots/inch) thermal print head which will allow very clear print at a printing speed of 3, 5, 8, 10 or 12 inches/sec.

B-EX6T1/T3-TS/GS12
305dpi/203dpi
3ips
5ips
8ips
10ips
12ips

## 1.3 Unpacking

### NOTES:

1. Check for damage or scratches on the printer. However, please note that TOSHIBA TEC shall have no liability for any damage of any kind sustained during transportation of the product.
2. Keep the cartons and internal packing for future transportation of the printer.

- Comes with USB I/F, LAN I/F, the RTC/USB host I/F card, Ribbon Save Module (for Type 1)  
Besides the optional Cutter Module, there is also an optional Peel off Module, Fanfold paper guide, RS-232C I/F card, Centronics I/F card, Expansion I/O Card, Wireless LAN I/F card, and RFID module

Unpack the printer as per the Unpacking Instructions supplied with the printer.

## 1.4 Accessories

When unpacking the printer, please make sure all the following accessories are supplied with the printer.

Power cord (for China)

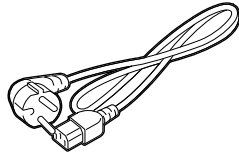

CD-ROM(1pc.)



Safety precautions

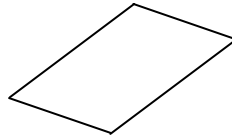

Quick installation manual

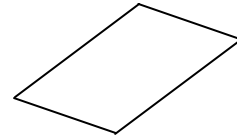

## 1.5 Appearance

The names of the parts or units introduced in this section are used in the following chapters.

### 1.5.1 Dimensions

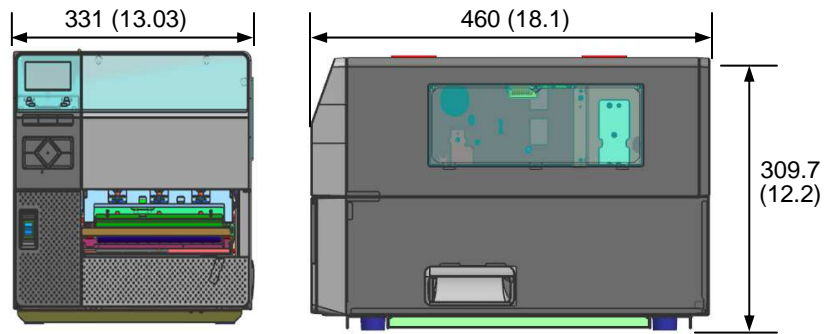

Dimensions in mm (inches)

### 1.5.2 Front View

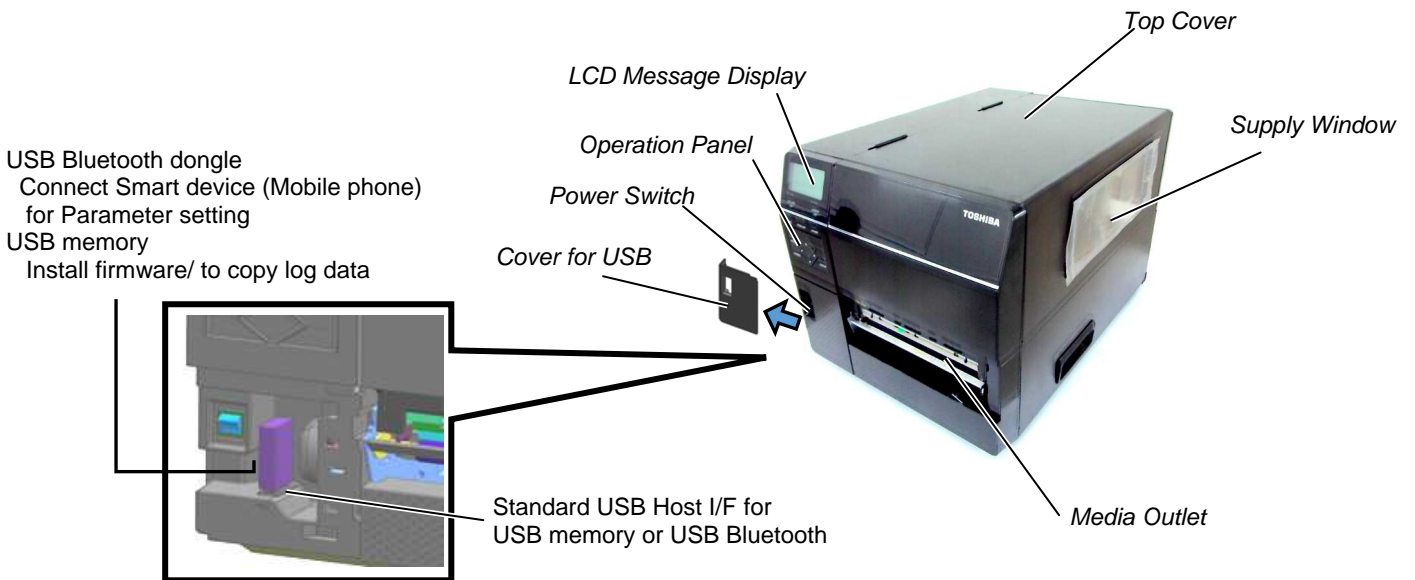

### 1.5.3 Rear View

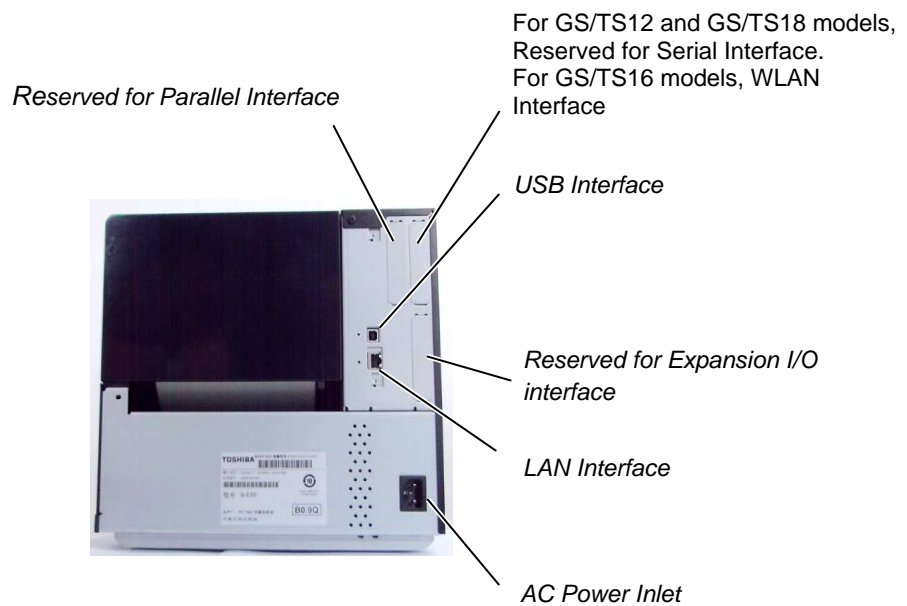

**1.5.4 Operation Panel**

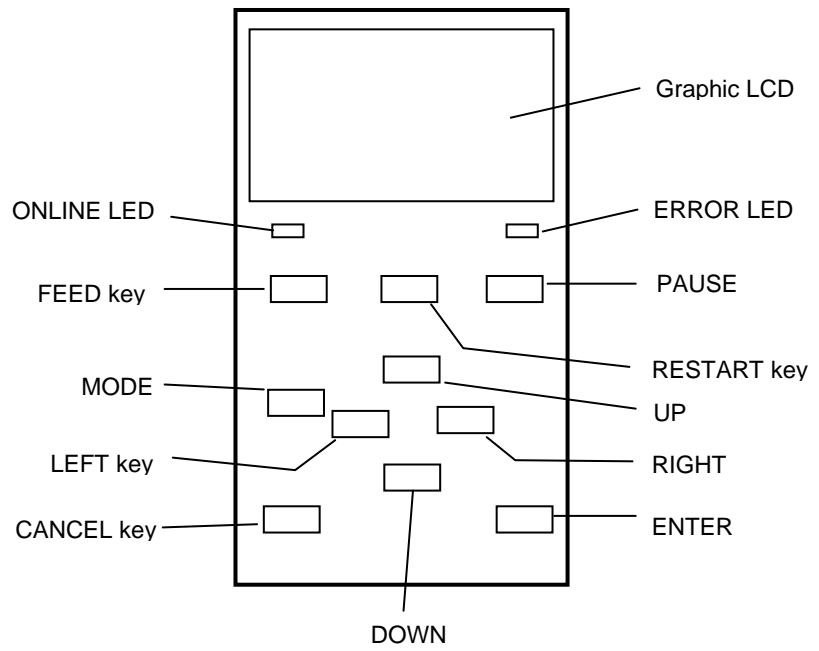

**1.5.5 Interior**

Please see **Section 3** for further information about the Operation Panel.

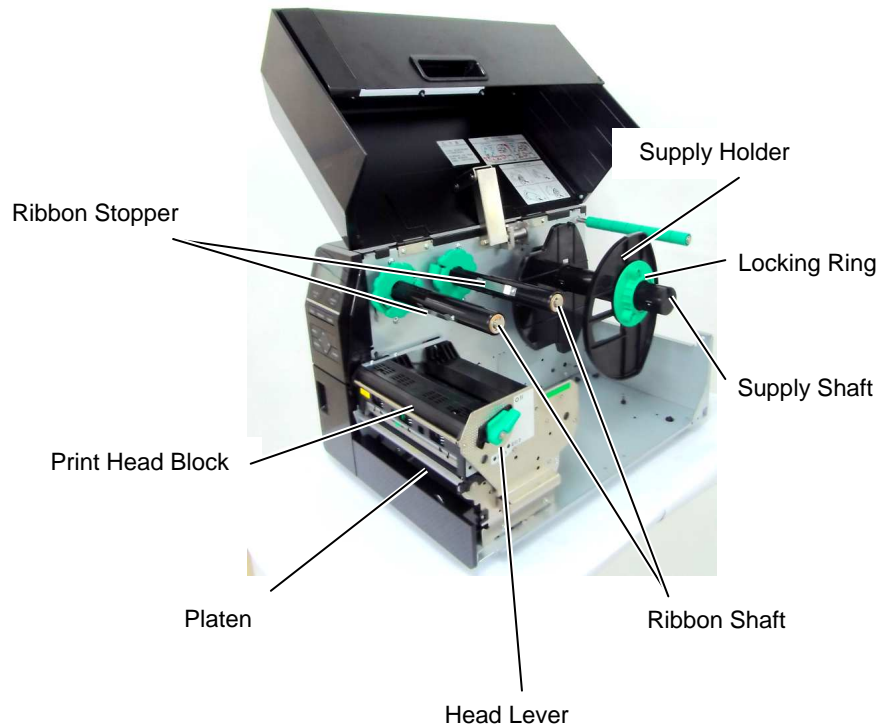

## 1.6 Options

Option Name	Type	Description
Disc cutter module	B-EX206-QM-R	Disc cutter To perform a cut the media feeds to the cut position, stops and is cut , then back feeds to the print position
Peel Off module	B-EX906-H-QM-R	This enables on-demand (peel-off) operations.
Fanfold paper guide	B-EX906-FF-QM-R	
RFID module	B-EX706-RFID-U4-EU-R B-EX706-RFID-U4-US-R B-EX706-RFID-U4-AU-R	Installing this module enables read and write of UHF RFID tags. Note GS/TS12-CN-R do not support the RFID option I/F. (Please purchase the GS/TS18-CN-R when RFID is needed.)
Expansion I/O interface card	B-EX700-IO-QM-R	Installing this card in the printer allows connection to an external device with the exclusive interface.
Parallel interface card	B-EX700-CEN-QM-R	Installing this card provides a Centronics interface port.
Serial interface card	B-EX700-RS-QM-R	Installing this card provides an RS-232C interface port.
Wireless LAN interface card	B-EX700-WLAN2-QM-R	Installing this card provides Wireless LAN Communication. Note: GS/TS12-CN-R do not support the WLAN option I/F. (Please purchase the GS/TS16-CN-R when WLAN I/F is needed.)

**NOTE:**

*To purchase the optional kits, please contact the nearest authorised TOSHIBA TEC representative or TOSHIBA TEC Head Quarters.*

## 2. PRINTER SETUP

This section outlines the procedures to setup your printer prior to its operation. The section includes precautions, loading media and ribbon, connecting cables, setting the operating environment of the printer and performing an online print test.

Setup Flow	Procedure	Reference
Installation	After referring to the Safety Precautions in this manual, install the printer in a safe and stable location.	2.1 Installation
Connecting the power cord	Connect a power cord to the power inlet of the printer, then to an AC outlet.	2.2 Connecting the Power Cord
Loading the media	Load a label stock or tag stock.	2.3.1 Loading the Media
Media sensor position alignment	Adjust the position of feed gap sensor or black mark sensor according to the media being used.	2.3.1 Loading the Media
Loading the ribbon	If using thermal transfer media then load the ribbon.	2.3.2 Loading the Ribbon
Connecting to a host computer	Connect the printer to a host computer or network.	2.4 Connecting the Cables to Your Printer
Turning the power ON	Turn on the printer power.	2.5 Turning the Printer ON/OFF
Printer setting	Set the printer parameters in the system mode.	2.6 Printer Setting
Installing the printer driver	If necessary, install the printer driver on your host computer.	2.7 Installing the Printer Drivers
Print test	Make a print test from your operating environment and check the print result.	2.8 Print Test
Position and Print Tone Fine adjustment	If necessary, fine adjust the print start position, cut/strip position, print tone, etc.	2.9 Position and Print Tone Fine Adjustment
Automatic threshold setting	If the print start position cannot be detected properly when pre-printed label are used, set the threshold automatically.	2.10 Threshold Setting
Manual threshold setting	If the print start position cannot be detected properly even after automatic threshold setting is performed manually set the threshold.	2.10 Threshold Setting

## 2.1 Installation

To insure the best operating environment and to assure the safety of the operator and equipment, please observe the following precautions.

- Operate the printer on a stable, level surface in a location free from excessive humidity, high temperature, dust, vibration and direct sunlight.
- Keep your work environment static free. Static discharge can cause damage to delicate internal components.
- Make sure the printer is connected to a clean source of AC power and no other high-voltage devices, that may cause line noise interference, are connected to the same mains.
- Assure that the printer is connected to the AC mains with a three-prong power cable that has the proper ground (earth) connection.
- Do not operate the printer with the cover open. Be careful not to allow fingers or articles of clothing to get caught in any of the moving parts, especially the optional cutter mechanism.
- For best results, and longer printer life, use only TOSHIBA TEC recommended media and ribbons.
- Store the media and ribbons in accordance with their specifications.
- This printer mechanism contains high-voltage components; therefore you should never remove any of the covers of the machine as you may receive an electrical shock. Additionally, the printer contains many delicate components that may be damaged if accessed by unauthorised personnel.
- Clean the outside of the printer with a clean, dry cloth or a clean cloth slightly dampened with a mild detergent solution.
- Use caution when cleaning the thermal print head as it will become very hot while printing. Wait until it has had time to cool before cleaning. Use only the TOSHIBA TEC recommended print head cleaner to clean the print head.
- Do not turn off the printer power or remove the power plug while the printer is printing or while the ON LINE lamp is flashing.



## 2.2 Connecting the Power Cord

### CAUTION!

1. Make sure that the printer Power Switch is turned to the OFF (O) position before connecting the Power Cord to prevent possible electric shock or damage to the printer.
2. Connect the Power Cord to a supply outlet with a properly grounded (earthed) connection.

1. Make sure that the printer Power Switch is in the OFF (O) position. Connect the Power Cord to the printer as shown in the figure below.



Power Switch



Power Cord

2. Plug the other end of the Power Cord into a grounded outlet as shown in the figure below.

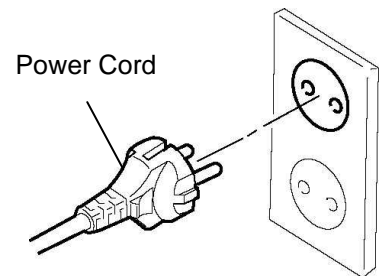
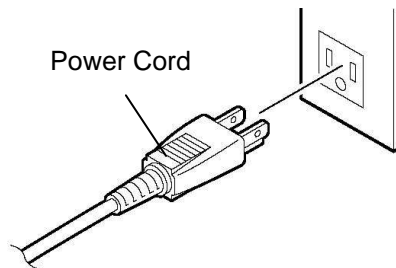

[US Type][EU Type]

## 2.3 Loading Supplies

### WARNING!

1. Do not touch any moving parts. To reduce the risk of fingers, jewellery, clothing, etc., being drawn into the moving parts, be sure to load the media once the printer has stopped moving completely.
2. The Print Head becomes hot immediately after printing, allow it to cool before loading the media.
3. To avoid injury, be careful not to trap your fingers while opening or closing the cover.

### CAUTION!

1. Be careful not to touch the Print Head Elements when lifting the Print Head Block. This may cause missing dots due to static electricity or other print quality problems.
2. When loading or replacing the media or ribbon, be careful not to damage the print head with hard objects like watches or rings.

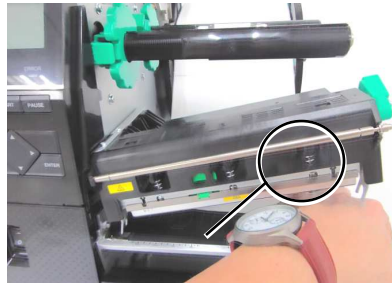

Care must be taken not to allow the metal or glass part of a watch to touch the print head edge.

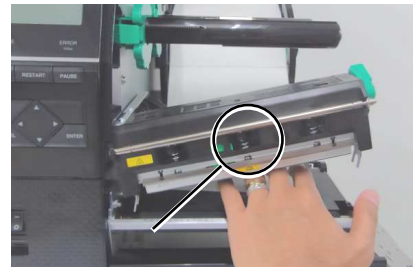

Care must be taken not to allow a metal object like a ring to touch the print head edge.

Since the print head element can be easily damaged by shock, please treat it carefully and do not hit it with hard objects.

### 2.3.1 Loading the Media

The following procedure shows the steps to properly load the media into the printer so that it feeds straight through the printer.

The printer prints both labels and tags.

1. Open the Top Cover.
2. Turn the Head Lever to the **FREE** position and release the Print Head Block Holder Plate.
3. Open the Print Head Block.

**NOTES:**

1. When the Head Lever is turned to **FREE** position, the Print Head can be raised.
2. Do not turn the Locking Ring on the supply holder counterclockwise too far or it may come off the Supply Holder.

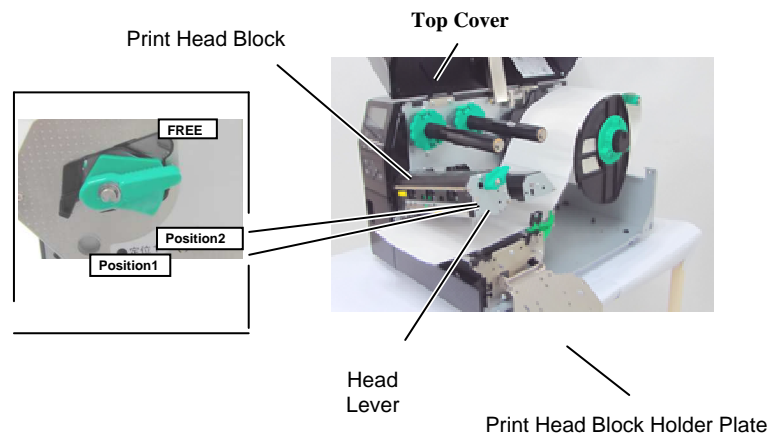

4. Turn the Locking Ring counterclockwise and remove the Supply Holder from the Supply Shaft.

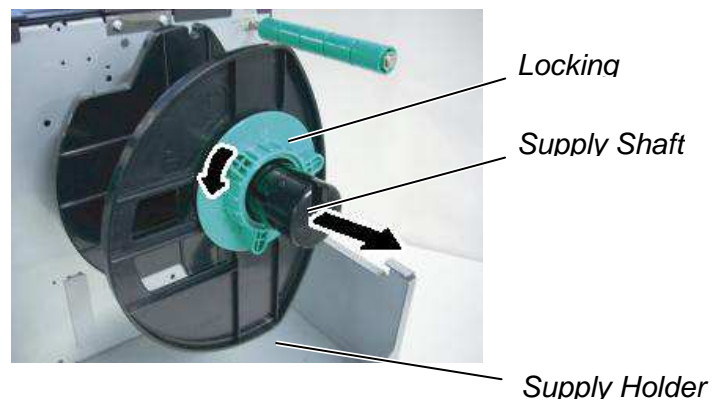

5. Put the media on the Supply Shaft.
6. Pass the media around the Guide Shaft, then pull the media towards the front of the printer.

### 2.3.1 Loading the Media (Cont.)

**NOTE:**  
Do not over-tighten the Locking Ring of the Supply Holder.

- Align the tab of the Supply Holder with the groove in the Supply Shaft, and push the Supply Holder against the media until the media is held firmly in place. This will center the media automatically. Turn the Locking Ring clockwise to secure the Supply Holder.

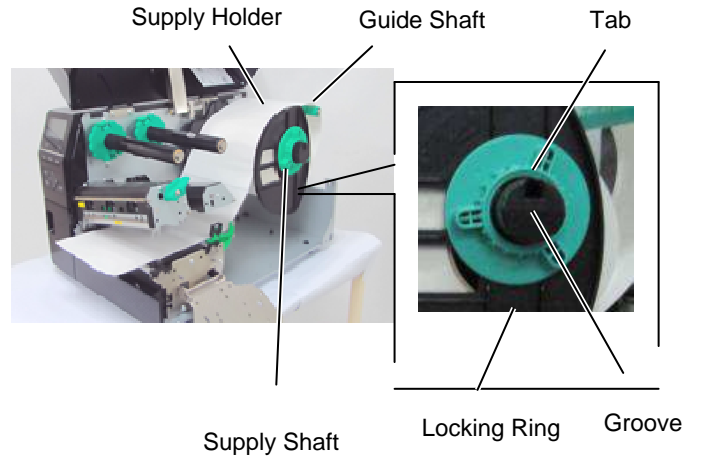

In the case of media which is inside wound.

In the case of media which is outside wound.

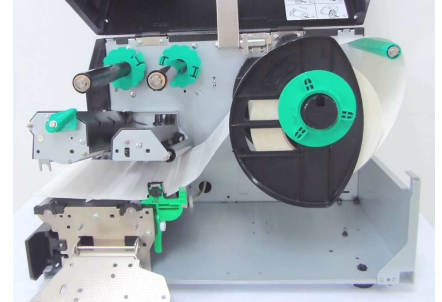
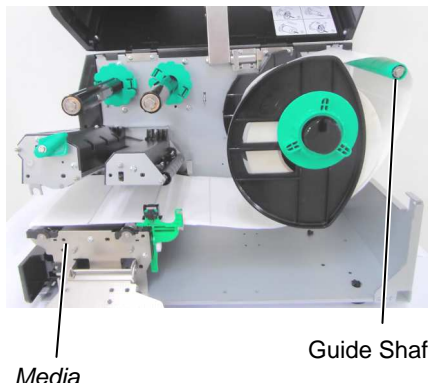

- Place the media between the Media Guides and adjust them to the media width. Once in the correct position tighten the Locking Screw.
- Check that the media's path through the printer is straight. The media should be centered under the Print Head.

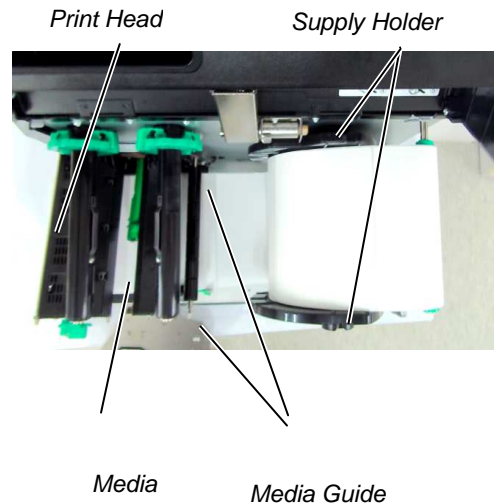
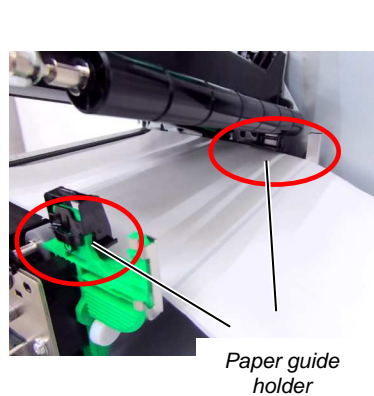

### 2.3.1 Loading the Media (Cont.)

10. Lower the Print Head Block.

11. Once the media is loaded it may be necessary to set the Media Sensors used to detect the start position for label or tag.

#### Setting the Feed Gap Sensor position

(1) Manually move the Media Sensor so that the Feed Gap Sensor is positioned at the centre of the labels. (● indicates the position of the Feed Gap Sensor).

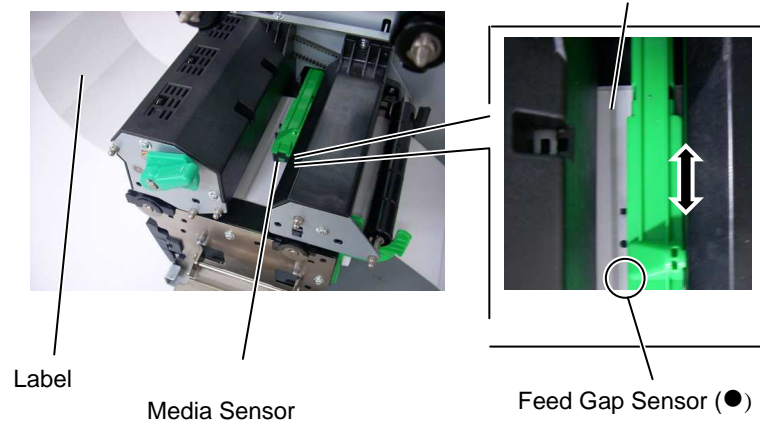

**NOTE:**

*Be sure to set the black mark sensor to detect the centre of the black mark, otherwise a paper jam or no paper error may occur.*

#### Setting the Black Mark Sensor position

(1) Pull about 500 mm of media out of the front of the printer, turn the media back on itself and feed it under the Print Head past the sensor so that the black mark can be seen from above.

(2) Manually move the Media Sensor so that the Black Mark Sensor is in line with the center of the black mark on the media. (■ indicates the position of the Black Mark Sensor).

Black Mark

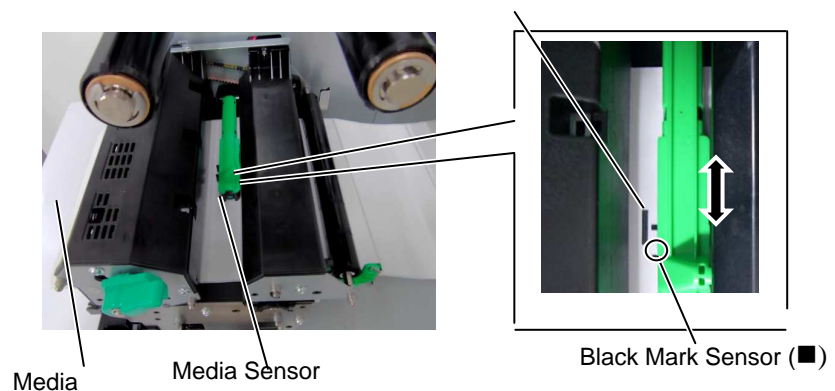

### 2.3.1 Loading the Media (Cont.)

#### 12. Batch mode

In batch mode, the media is continuously printed until the number of labels/tags specified in the issue command has been printed.

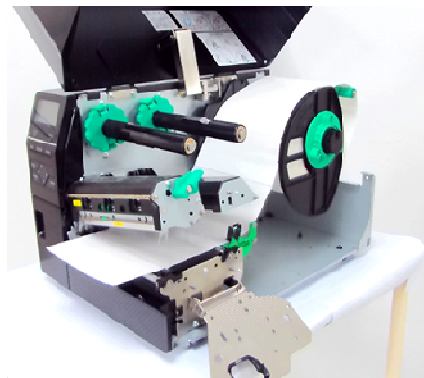

#### 13. Loading with peel off module

When the optional Strip Module is fitted, the label is automatically removed from the backing paper at the Strip Plate as each label is printed.

#### NOTES:

1. Be sure to set the Selection Switch to **STANDARD/PEEL OFF** position.
2. The backing paper is easier to feed back to the Take-Up Spool if the Front Plate is removed.
3. Fit the Take-Up Clip so that the longer side of the clip is fitted into the shallow groove in the Take-Up Spool.
4. The backing paper can be wound directly onto the Take-up Spool or a paper core.

- (1) Remove enough labels from the leading edge of the media to leave 500mm of backing paper free.
- (2) Insert the backing paper under the Strip Plate.
- (3) Wind the backing paper onto the Take-up Spool and fix it in position with the Take-up Clip. (Wind the paper counter-clockwise around the spool.)
- (4) Rotate the Take-up Spool counter-clockwise a few times to remove any slack in the backing paper.

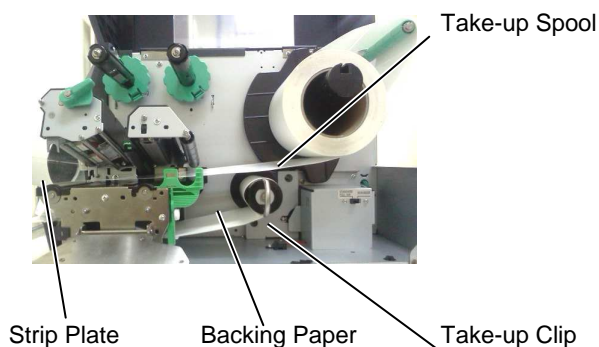



### 2.3.2 Loading the Ribbon

**NOTES:**

1. When attaching the ribbon stoppers, make sure that the pinchers face into the printer
2. Be sure to remove any slack in the ribbon before printing. Printing with a wrinkled ribbon will reduce the print quality.
3. The Ribbon Sensor is mounted on the rear of the Print Head Block to detect a ribbon end. When a ribbon end is detected a "NO RIBBON" message will appear on the display and the ERROR LED will illuminate.

There are two types of media available for printing on: thermal transfer and direct thermal (which has a chemically treated surface). DO NOT LOAD a ribbon when using direct thermal media.

1. Grasp the tabs on the top and bottom of the Ribbon Stoppers and move them back to the end of the Ribbon Shaft.

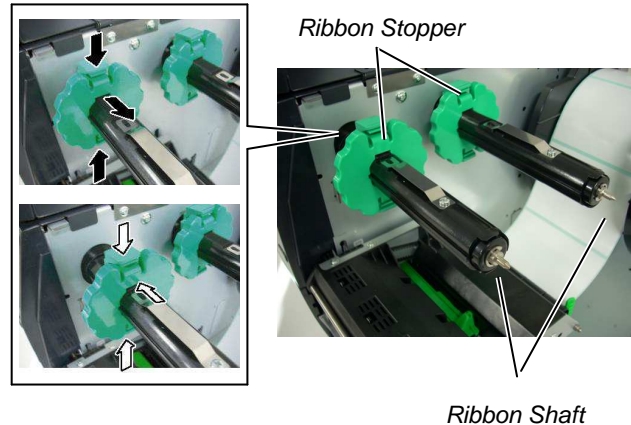

2. Leaving plenty of slack between the ribbon spools, place the ribbon onto the Ribbon Shafts as shown below.

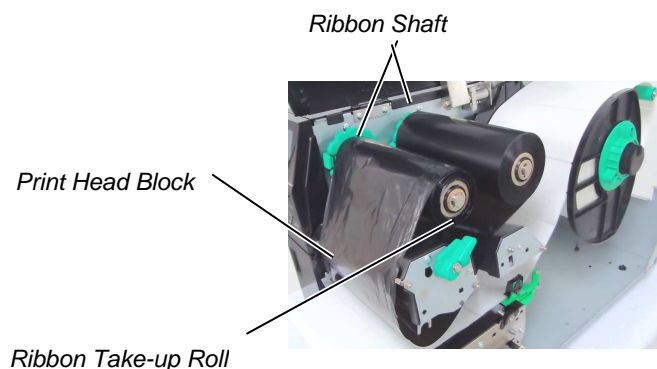

#### Ribbon path

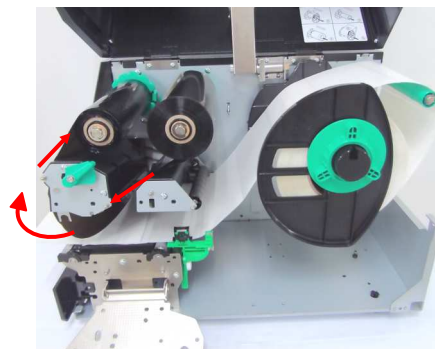



### 2.3.2 Loading the Ribbon (Cont.)

3. Slide the Ribbon Stoppers along the Ribbon Shafts so that the ribbon will be centered when fitted.
4. Lower the Print Head Block and set the Print Head Block Holder Plate .
5. Take up any slack in the ribbon. Wind the leading tape onto the ribbon take-up roll until the ink ribbon can be seen from the front of the printer.

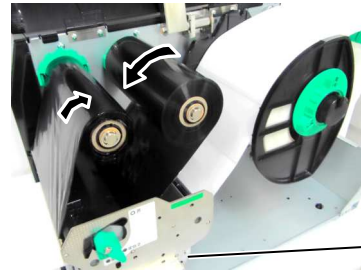

*Print Head Holder  
Block Plate*

6. Turn the Head Lever to **Lock** position to close the Print Head.
7. Close the Top Cover.

#### ■ Auto Ribbon Saving Mode

B-EX6T1 has a ribbon saving function, it is possible to reduce ribbon waste by stopping the ribbon feed for non-print areas. To activate the ribbon save a minimum non-print area is required as below.

203 & 305 dpi models (mm)

Print speed	3 ips	5 ips	8 ips	10 ips	12 ips
Min. non-print area	20	20	25	35	60

## 2.4 Connecting the Cables to Your Printer

The following paragraphs outline how to connect the cables from the printer to your host computer, and will also show how to make cable connections to other devices. Depending on the application software you use to print labels, there are 5 ways to connect the printer to your host computer. These are:

- An Ethernet connection using the printer's standard LAN connector.
- A USB cable connection between the printer's standard USB connector and your host computer's USB port. (Conforming to USB 2.0)
- A serial cable connection between the printer's optional RS-232 serial connector and one of your host computer's COM ports.
- A parallel cable connection between the printer's optional parallel connector and your host computer's parallel port (LPT).
- Wireless LAN using an optional Wireless LAN board.

For details, refer to **APPENDIX 2**.

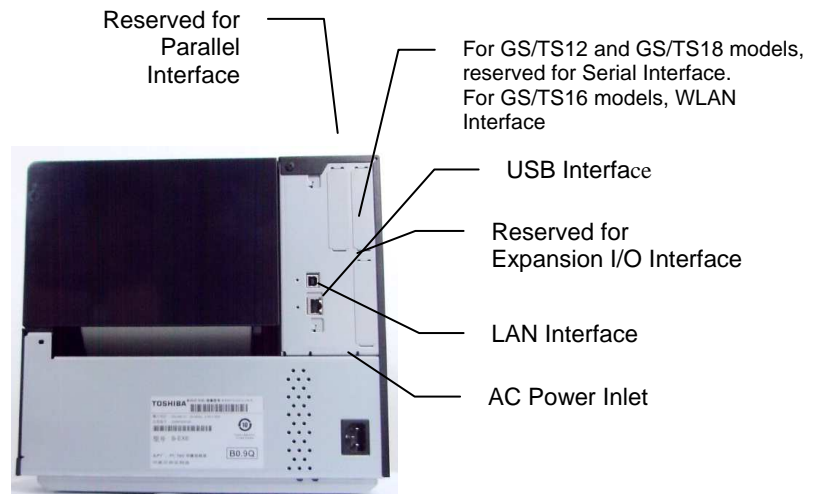

## 2.5 Turning the Printer ON/OFF

When the printer is connected to your host computer it is good practice to turn the printer ON before turning on your host computer and turn OFF your host computer before turning off the printer.

### 2.5.1 Turning ON the Printer

#### CAUTION!

Use the power switch to turn the printer On/Off. Plugging or unplugging the Power Cord to turn the printer On/Off may cause fire, an electric shock, or damage to the printer.

#### NOTE:

If a message other than ON LINE appears on the display or the ERROR LED lamp is illuminated, refer to **Section 5.1, Error Messages**.

1. To turn ON the printer power, press the Power Switch as shown in the diagram below. Note that (|) is the power ON side of the switch.



Power Switch

2. Check that the ON LINE message appears in the LCD Message Display and that the ON LINE and POWER LED lights are illuminated.

### 2.5.2 Turning OFF the Printer

#### CAUTION!

1. Do not turn off the printer power while the media is being printed, as this may cause a paper jam or damage to the printer.
2. Do not turn off the printer power while the ON LINE lamp is blinking as this may cause damage to your computer.

1. Before turning off the printer Power Switch verify that the ON LINE message appears in the LCD Message Display and that the ON LINE LED light is on and is not flashing.
2. To turn OFF the printer power press the Power Switch as shown in the diagram below. Note that (O) is the power OFF side of the switch.



Power Switch

## 2.6 Printer Setting

### 2.6.1 SCOPE

This specification describes key operations using the keys and the LCD of the B-EX6T series high-end industrial bar code printers.

### 2.6.2 OUTLINE

Key operations are different depending on the printer mode: Online mode in which operations are carried out through the keys and error messages are displayed while the printer is connected to the host such as a PC, and the system mode in which self-diagnosis and setting of various parameters are performed.

This specification describes the key operation procedures with the printer keys and the LCD.

The names of the keys and LCD messages used in this specification are written in English

### 2.6.3 OPERATION PANEL

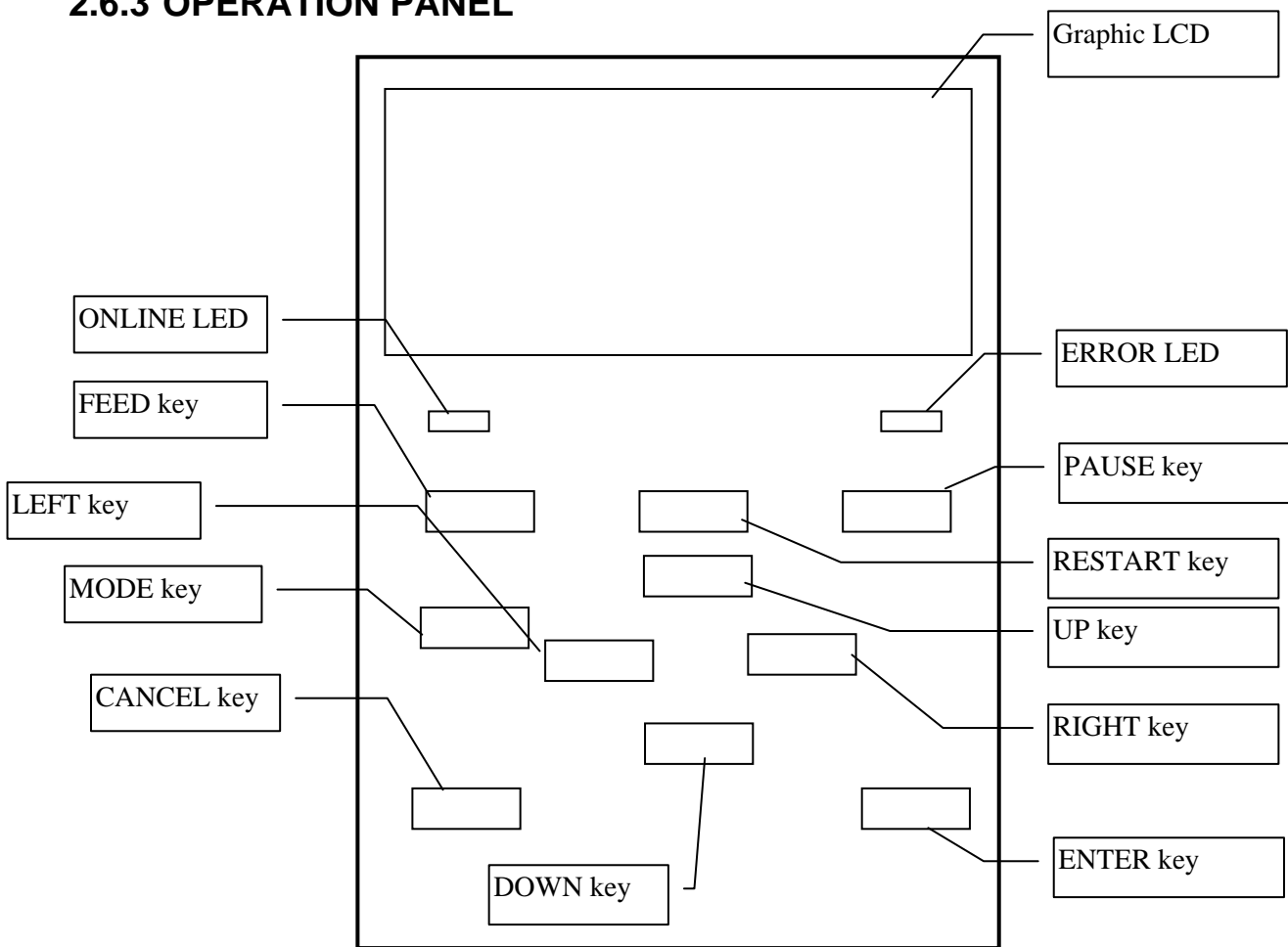

## 2.6.4 OUTLINE OF EACH MODE

This chapter describes the outline of each mode supported by the printer. Refer to each chapter for detailed information.

### 2.6.4.1 ONLINE MODE

This mode is mainly used by users (operators).

The label or tag can be issued in the online mode. When an error occurs, the help function shows the cause of the error, troubleshooting, and recovery from the error. The threshold setting, described below, is also a part of the online mode.

#### 2.6.4.1.1 Threshold setting mode

Threshold setting mode is provided to correct a print failure with pre-printed media.

When using pre-print label, print start positions may not be detected correctly with the usual media sensor threshold, depending on the ink type. Such error can be prevented by setting the threshold just for the pre-printed media to be used. Since the threshold setting value is stored in the non-volatile memory, it is unnecessary to set the threshold again as long as the same pre-print media is used.

#### 2.6.4.1.2 RFID calibration mode

In the RFID calibration mode, the distance to the optimum tag write/read position and AGC value required for properly writing/reading data on/from RFID tags are obtained through a calibration, the obtained values are set on the printer automatically, and they are reflected in the printer operation. To write/read data on/from RFID tags with the bar code printer, it was necessary to manually set a distance to the write/read position and an AGC value, used for detecting the target tag, with @003 command and in the system mode. However, these are automatically done in the RFID calibration mode.

#### 2.6.4.1.3 Information mode

In the information mode, the total feed amount counted during feeding and printing operations is displayed on the LCD in units of centimeter and inch.

Printing of the feed amount is performed on request.

### 2.6.4.2 USER SYSTEM MODE

The user system mode is accessible from the online mode. This mode contains parameters and settings which might be frequently changed by users (administrator) or service persons.

In addition to the functions of parameter setting and fine adjustment (in common with the System Mode), there are the following additional features, issue condition display function, manual threshold setting, and system tools menu .

The values set in these modes are stored in the non-volatile memory.

### 2.6.4.3 SYSTEM MODE

This mode is mainly used by service persons or the production department staff for adjustment of the printer before shipment. System mode contains settings which should not be changed so frequently.

In addition to the parameter setting and fine adjustment menus (in common with the User System Mode), there are sensor adjustment, interface, RFID, RTC and BASIC setting menus.

Other extended functions are self-diagnosis, test print, RAM clear (re-initialize the printer), pre-shipment adjustments for factory use, and the menu which enables saving parameter settings, external characters, TPCL commands to an external USB memory stick or copying data from a USB memory stick to the printer. The values set in this mode are stored in the non-volatile memory.

### 2.6.4.4 DOWNLOAD MODE

This mode is used to download boot and main programs.

#### 2.6.4.4.1 AUTO CONFIGURATION MODE



In this mode, the printer firmware is automatically updated with the program stored in a USB memory stick.

## 2.6.5 GENERAL VIEW OF KEY OPERATION

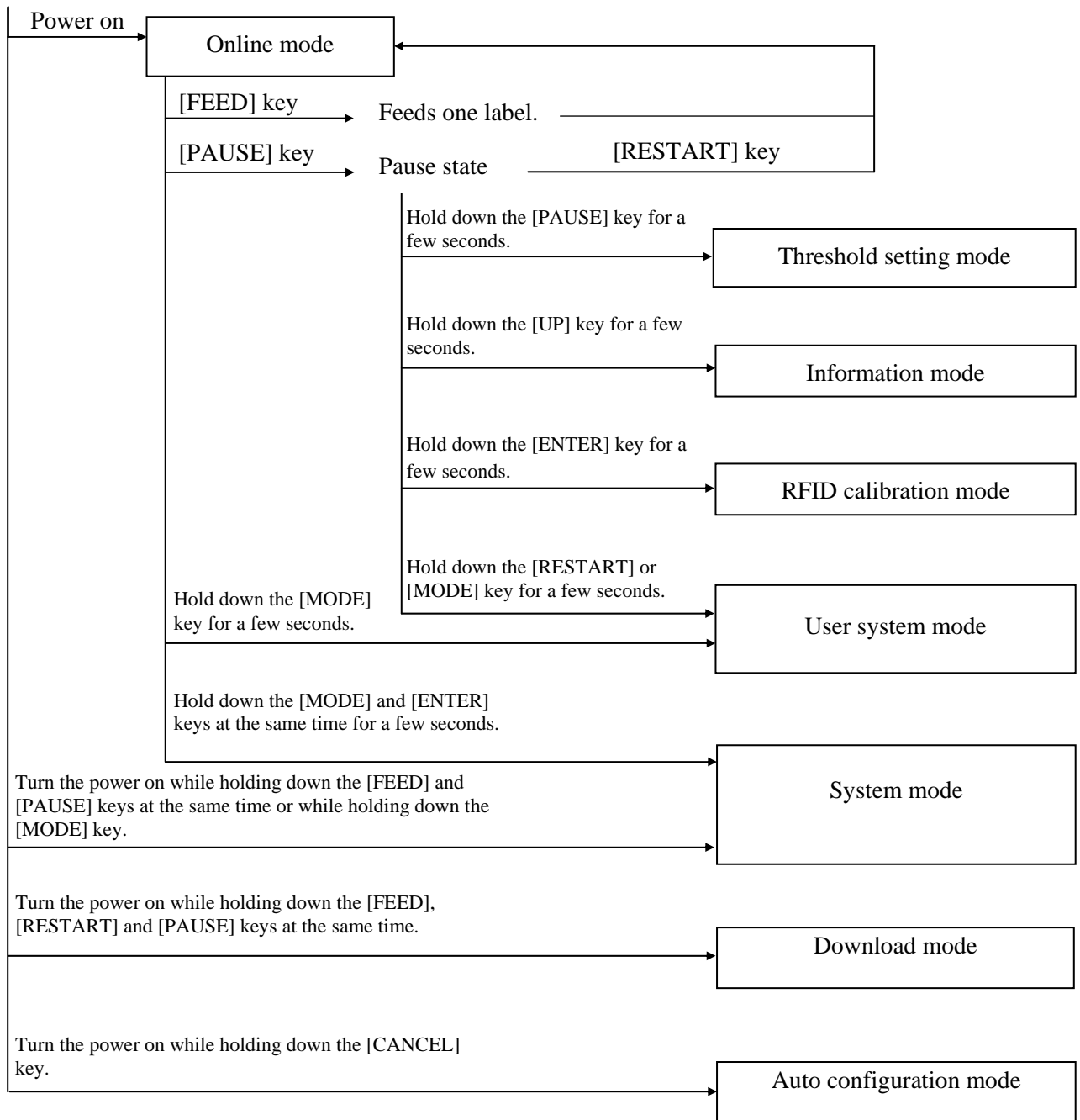
[Power OFF]

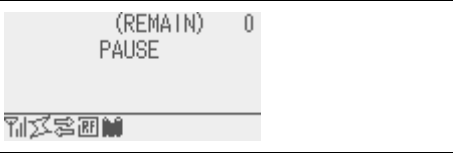

<Example of the screens>

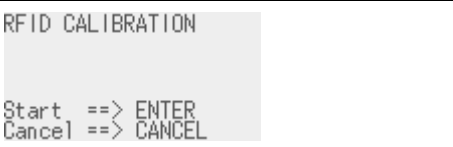
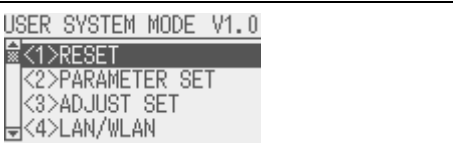
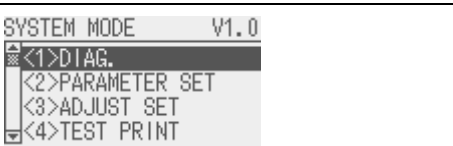
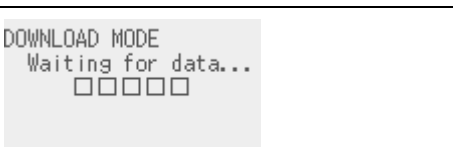
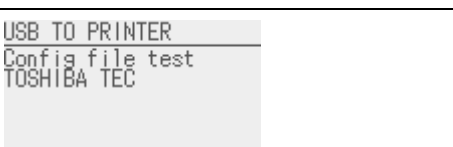
Pause state	
Threshold setting mode	
RFID calibration mode	
Information mode	
User system mode	
System mode	
Download mode	
Auto configuration mode	

**Notes:**

1. To enter the download mode, system mode or auto configuration mode, keep holding down the specified key until the menu is displayed.
2. Power off  
 When the power of the printer is turned off, the ONLINE and ERROR LEDs synchronously flash at a 500-ms interval (ON: 250ms, OFF: 250ms). When the LEDs are unlit, the printer power turns off.  
 The printer power should not be turned on again while these LEDs are flashing. Otherwise, a “SYSTEM ERROR 02 POWER FAILURE” message will be displayed, and the LCD message may corrupt before the error message is displayed.

## 2.6.6 Initial Setting Wizard

THE first time the printer is used after opening carton box or after a RAM clear, the initial setting wizard will start when the power is switched on. This wizard enables setting basic parameters, such as the LCD language and print mode. The values set with this wizard can be changed in the system mode and also by command.

Example of the Initial Setting Wizard Operation

	RAM clear with QM type selected	
1. Perform a RAM clear.		
	↓	
	↓ Power OFF/ON	
	↓	
2. The initial setting wizard starts.		
	↓ [ENTER] key	
3. Select a language.		Choose the desired option with the [UP] or [DOWN] key and press ENTER to set.
	↓ [ENTER] key	
4. Print mode		Choose the desired option with the [UP] or [DOWN] key and press ENTER to set.
	↓ [ENTER] key	
5. Select a calibration type.		Choose the desired option with the [UP] or [DOWN] key and press ENTER to set.
6.-1 When an option other than "OFF" is selected for CALIBRATE		



<p>6.-1-1 Finish</p>	<div style="border: 1px solid black; padding: 5px; margin-bottom: 5px;"> <p style="text-align: center;">INITIAL CONFIGURATION</p> <p style="text-align: center;">FINISH ?</p> <p style="text-align: center;">◀Prev                      ENTER: Finish</p> </div> <p style="text-align: center;">↓ [ENTER] key.</p> <p>7. The settings are saved.</p>	<p>Press ENTER to finish.</p>
<p>6.-2 When "OFF" is selected for CALIBRATE</p>		
<p>6.-2-1 Media detection</p>	<div style="border: 1px solid black; padding: 5px; margin-bottom: 5px;"> <p style="text-align: center;">PAPER DETECT    FEED/GAP</p> <p style="text-align: center;">▲</p> <div style="border: 1px solid black; padding: 2px; margin: 2px auto; width: 80%;"> <p style="text-align: center;">CONTINUOUS</p> <p style="text-align: center;">LABEL/GAP</p> <p style="text-align: center;">BLACK MARK</p> </div> <p style="text-align: center;">▼</p> <p style="text-align: center;">◀ Select                      ENTER: Set</p> </div> <p style="text-align: center;">↓ [ENTER] key</p>	<p>Choose the desired option with the [UP] or [DOWN] key and press ENTER to set.</p>
<p>6.-2-2 Media length</p>	<div style="border: 1px solid black; padding: 5px; margin-bottom: 5px;"> <p style="text-align: center;">PAPER LENGTH                      76mm</p> <div style="border: 1px solid black; padding: 2px; margin: 2px auto; width: 60%;"> <p style="text-align: center;">76 mm</p> </div> <p style="text-align: center;">(10 - 1500mm)</p> <p style="text-align: center;">◀ Select                      ENTER: Set</p> </div> <p style="text-align: center;">↓ [ENTER] key</p>	<p>Set the paper length with the [UP] or [DOWN] key and press ENTER to set.</p>
<p>6.-2-3 Finish</p>	<div style="border: 1px solid black; padding: 5px; margin-bottom: 5px;"> <p style="text-align: center;">INITIAL CONFIGURATION</p> <p style="text-align: center;">FINISH ?</p> <p style="text-align: center;">◀Prev                      ENTER: Finish</p> </div> <p style="text-align: center;">↓ [ENTER] key.</p> <p>7. The settings are saved.</p>	<p>Press ENTER to finish.</p>
<p>7. The settings are saved.</p>	<div style="border: 1px solid black; padding: 5px; margin-bottom: 5px;"> <p style="text-align: center;">SAVING SETTING...</p> </div> <p style="text-align: center;">↓</p>	
<p>8. DHCP client is initialized.</p>	<div style="border: 1px solid black; padding: 5px; margin-bottom: 5px;"> <p style="text-align: center;">DHCP CLIENT INIT...</p> </div> <p style="text-align: center;">↓</p>	
<p>9. Online mode</p>	<div style="border: 1px solid black; padding: 5px;"> <p style="text-align: center;">B-EX4T1-G                      C1.6</p> <p style="text-align: center;">ONLINE</p> <p>PRINTED                      000000</p> <p>IP: 192. 168. 010. 020</p> </div>	

## Key functions (Wizard screen)

Key	Substitute key	Function
[MODE]	None	Returns to the top page without saving the changes.
[CANCEL]	[FEED] + [RESTART]	Returns to the upper level menu without saving the changes.
[ENTER]	[PAUSE]	In the case of option selection screen, saves the changes and displays the next screen.
[UP]	[RESTART]	Moves the cursor upward. When the cursor is positioned at the top of the list, it scrolls from the top to the bottom.
[DOWN]	[FEED]	Moves the cursor downward. When the cursor is positioned at the bottom of the list, it scrolls from the bottom to the top.
[LEFT]	None	Displays the next screen without saving the changes.
[RIGHT]	None	Displays the upper-level screen without saving the changes.

## 2.7 Printer Drivers

Once you install the TOSHIBA printer driver on your Windows host computer, you can use the TOSHIBA bar code printer in the same way you would a laser or ink jet printer.

You can use the printer by connecting a USB or LAN cable to your host computer.

The installation procedure of the printer driver differs depending on the printer model and the connection method.

The Printer driver and installation manual can be downloaded from the Toshiba TEC Web-site

[http://www.toshibatec-ris.com/products/barcode/download/driver\\_agreement.html](http://www.toshibatec-ris.com/products/barcode/download/driver_agreement.html)

If an older version of the printer driver has been already installed, you must uninstall it and restart the computer before installing a newer version.

## 2.8 Print Test

After your drivers have been installed , perform a print test.

Performing a print test using the Printer Driver

The printer driver's Properties screen allows you to set the communication conditions, media size, and other printing conditions in accordance with your operating environment. For details, refer to the **Help for the Windows Printer Drivers** screen.

Example: Stock tab display of the Printer Driver's Properties Screen

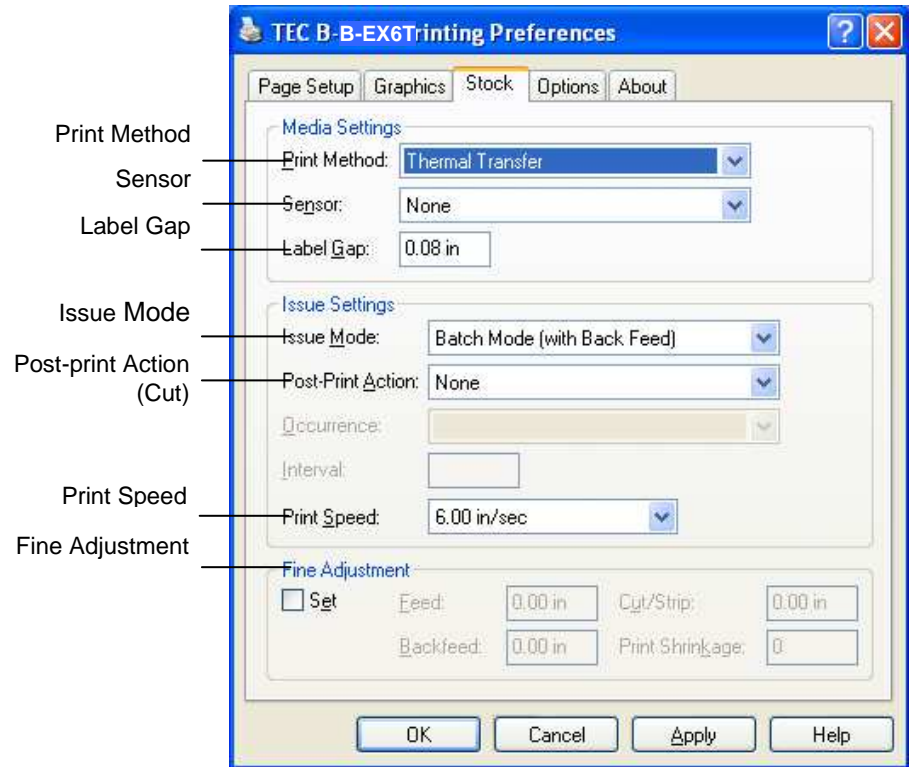

- Print Method: Direct thermal or thermal transfer is selectable.
- Sensor: Media sensor type is selectable.
- Issue Mode: Batch, strip or cut is selectable.
- Post-print Action: Whether to use the cutter or not is selectable.
- Fine Adjustment: Adjustment values for the feed amount, cut/strip position, etc. can be set.

## 3. ONLINE MODE

### 3.1 Key Functions

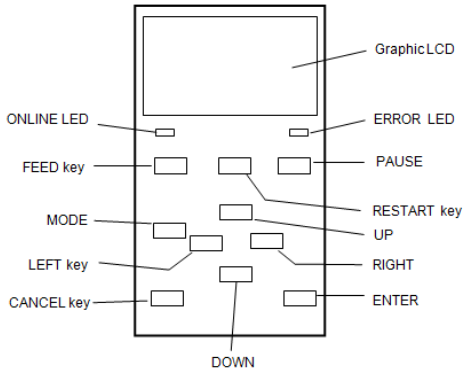

This chapter describes the usage of the keys on the Operation Panel in Online mode.

When the printer is in Online mode and connected to a host computer, the normal operation of printing on labels or tags can be accomplished.

#### ■ Key functions in the online mode

Key	Function
[FEED]	(1) Feeds the set media length. (2) Prints the data in the image buffer according to the system mode setting. (3) Clears the help message.
[RESTART]	(1) Resumes printing after a temporary pause in printing or after an error. (2) Places the printer in the initial state which is obtained when the power is turned on. (3) Places the printer in the user system mode. (4) Clears the help message.
[PAUSE]	(1) Stops printing temporarily. (2) Programs the threshold values. (3) Clears the help message.
[MODE]	(1) Places the printer in the user system mode. (2) Clears the help message.
[CANCEL]	(1) Clears the job. (2) Displays previous help message page.
[ENTER]	(1) Displays next help message page. (2) Clears the help message.
[UP]	(1) Scrolls up
[DOWN]	(1) Scrolls down
[LEFT]	(1) Displays previous help message page.
[RIGHT]	(1) Displays next help message page.

## 3.2 LCD

## Online state

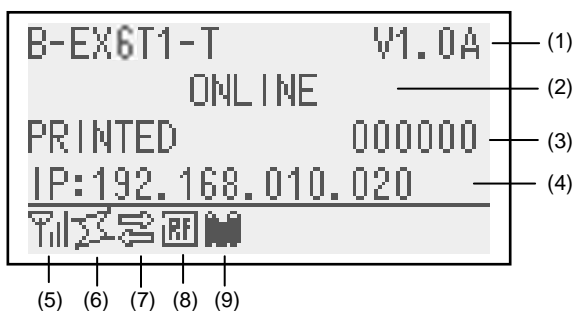

## Error state

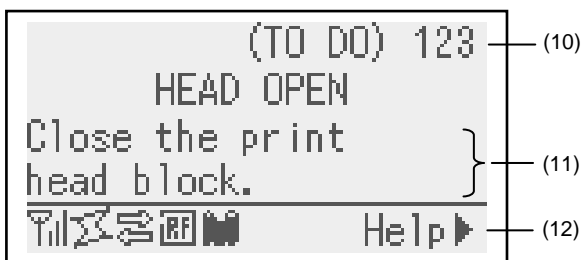











(Example: Head open error)

No.	Description
(1)	Model name and firmware version
(2)	Message
(3)	The number of labels printed
(4)	IP address (only when LAN/WLAN is enabled.)
(5)	Radio signal strength (only when WLAN is enabled.) Indicates the strength of the radio signal in 4 levels.
(6)	WLAN connection (only when WLAN is enabled.) <ul style="list-style-type: none"> <li>▪ Lights up when connecting to an access point.</li> <li>▪ Flashes while roaming.</li> <li>▪ Goes off when disconnected.</li> </ul>
(7)	Presence of a print job Appears when a print job exists.
(8)	RFID (only when RFID module is installed.) <ul style="list-style-type: none"> <li>▪ Appears when a communication between the printer and the RFID module is enabled.</li> <li>▪ Flashes while communicating with the RFID module.</li> </ul>
(9)	Ribbon near end Flashes when a ribbon near end state is detected.
(10)	The number of remaining labels to print
(11)	Error description and solution
(12)	Help guide Appears when a help guide message is provided. Press the [RIGHT] key to see the help guide message.

### 3.3 Icon

Five kinds of icon are displayed in the bottom line of the online mode screen.

These icons are displayed only in the online mode screen.

Icon	Explanation
Wireless LAN icon	<ul style="list-style-type: none"> <li>• Displayed and used when the wireless LAN module is installed.</li> <li>• The graph shows the radio field strength.</li> </ul>  Graph 0: Outside of communication range  Graph 1: Radio field strength is weak.  Graph 2: Radio field strength is middle.  Graph 3: Radio field strength is strong.
Link icon	<ul style="list-style-type: none"> <li>• Displayed and used when the wireless LAN module is installed.</li> <li>• Displayed while the printer is communicating by wireless LAN.</li> <li>• Flashes while roaming.</li> </ul>  OFF: No connection  ON: Connecting to an access point  Flashing: Roaming (*1)
Data transmission icon	<ul style="list-style-type: none"> <li>• Appears when a print job is present.</li> </ul>  ON: Print job is present.
RFID icon	<ul style="list-style-type: none"> <li>• Displayed and used when the RFID module is installed.</li> <li>• Appears when the RFID module type has been set and a communication between the printer and the RFID module is enabled.</li> <li>• Flashes while communications and operating sequence are made with the RFID module.</li> </ul> <p>-</p>  ON: Module type has been set and the printer is ready to communicate with the RFID module.  Flashing: Communicating
Ribbon near end icon	<ul style="list-style-type: none"> <li>• Ribbon near end is detected.</li> <li>• Flashes when the ribbon is close to the end.</li> <li>• Ribbon near end is detected depending on the diameter of unused ribbon. Ø38 mm is equivalent to 30-meter ribbon and Ø43 mm is equivalent to 70-meter ribbon.</li> </ul>  Flashing: Ribbon near end state (*1)

(\*1) The icon flashes at a 1-second interval (ON: 500 msec., OFF: 500 msec.)

### 3.4 Operation Example

#### ■ Online Mode

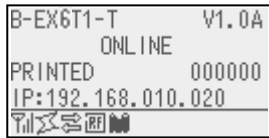

Idling or normal issuing

When [PAUSE] key is pressed while printing:



Printing is stopped.

When [RESTART] key is pressed, the printer resumes printing if there is remaining data.

If the print head is opened during idling:



Help guide is displayed.

Close the print head.

Press [RIGHT] key

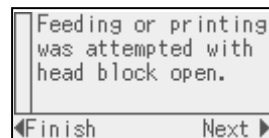

Help guide message for head open

If an error occurs while printing:



Printing is stopped and Help guide is displayed.

Load media.  
When [RESTART] key is pressed, the printer resumes printing if there is remaining data.

Press [RIGHT] key

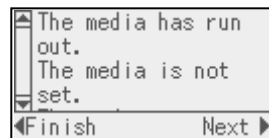

Help guide message for no paper



### 3.4 Operation Example (Cont.)

#### ■ Help Guide Message

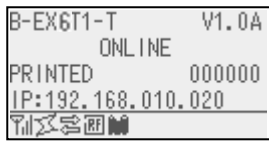

Idling or normal issuing

If an error occurs while printing:



Printing is stopped and Help guide is displayed.

Load media.  
When [RESTART] key is pressed, the printer resumes printing if there is remaining data.

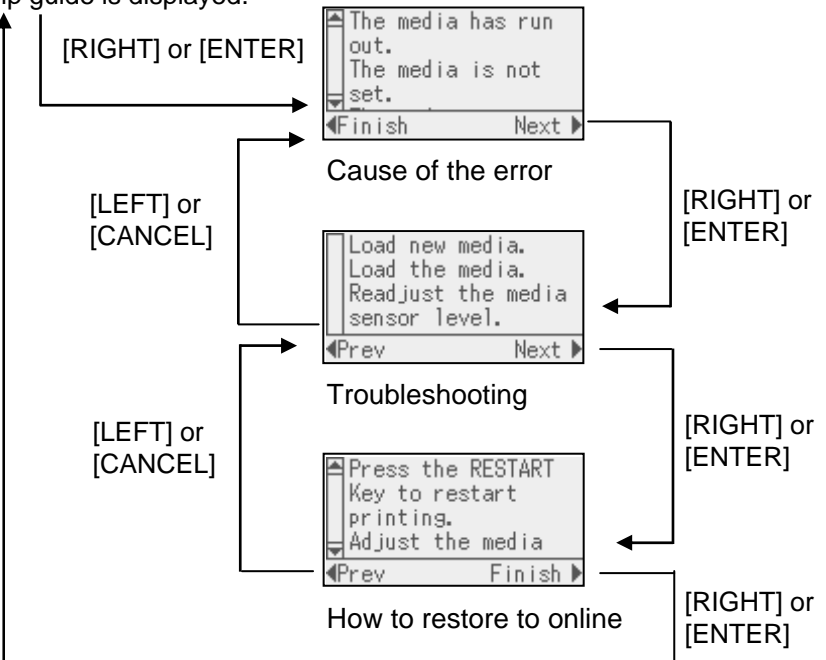

### 3.4 Operation Example (Cont.)

#### ■ Cancellation of Print Job

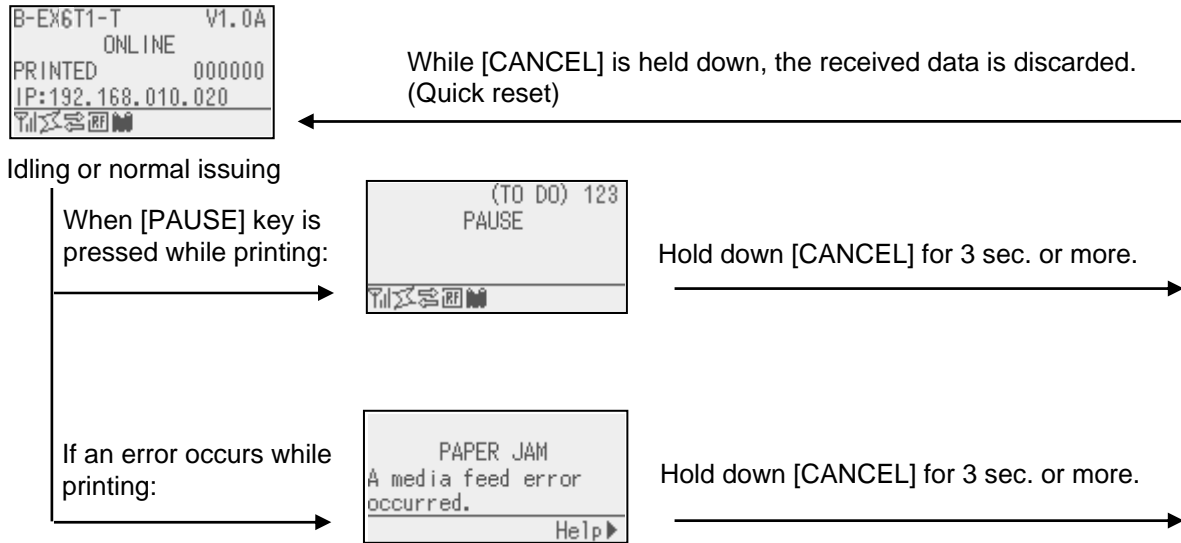

## 3.5 USER SYSTEM MODE

### 3.5.1 OUTLINE OF USER SYSTEM MODE

1. The printer enters the user system mode with the following operations.
  - While the printer is in pause state, perform either of the following operations:
    - Hold down the [RESTART] key for 3 sec. or more.
    - Hold down the [MODE] key for 3 sec. or more.
  - While the printer is in online, perform the following operation:
    - Hold down the [MODE] key for 3 sec. or more.
2. The user system mode is intended for performing parameter and other settings.
3. The key operations for the user system mode are described below.

For the key functions and display, please refer B-EX6T key operation manual.

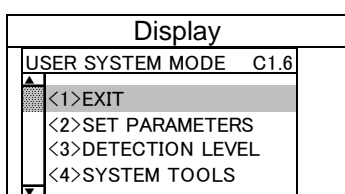

Top menu list

#### Outline of the top menu

<1>EXIT	Used to return the printer to online state. (The printer is not reset.)
<2>SET PARAMETERS	Used to set the parameters for each printer function.
<3>DETECTION LEVEL	Used to set the threshold value.
<4>SYSTEM TOOLS	Used to print data sent from the host or store it in USB memory.
<5>SHOW ISSUE CONDITION	Used to display the print conditions (such as sensor type, print speed and orientation).
<6>RESET	Used to reset the printer.

### 3.5.2 EXIT

The printer is returned from the user system mode to the online mode. (No reset is performed.)  
 Some parameter settings are reset when the Exit is performed. The parameters to be reset are indicated with "Reset Req.". Other parameters are not reset

## 3.6 Power Save Function

### 3.6.1 Entering the Power Saving Mode

When the printer stays in any of the following statuses for the specified length of time, it enters power saving mode.

- Online (Idle, communicating)
- Pause
- Error
- Waiting for label to be removed
- System mode (except for self-diagnosis, test print, sensor adjustment)
- User system mode (except for dump)
- Pause state of the expansion I/O

When the printer enters the power saving mode, “POWER SAVING MODE” is displayed on the LCD and the backlight goes off.

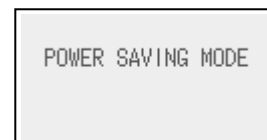

When the following occurs in the power saving mode, the LCD wakes up.

- A key is pressed. (Except for [RESTART] or [FEED] key which causes printing or paper feed.)
- The head lever is released and locked.
- The status of the pause or active signal of the expansion I/O changes.

The LCD shows “POWER SAVING MODE” and the backlight goes off again if no status change occurs on the printer for 15 minutes.

### 3.6.2 Exiting the Power Saving Mode

The printer exits the power saving mode when:

- Printing (printing caused by a depression of the [RESTART] key is included.) is performed.
- paper feed or re-print s caused by a depression of the [FEED] key
- printing or paper feed is initiated through the expansion I/O
- automatic calibration is performed
- sensor adjustment is performed in the system mode
- the printer receives commands (U1/U2, T, XS, IB, or RFID-related commands).

## 4. MAINTENANCE

### **WARNING!**

1. *Be sure to disconnect the power cord before performing maintenance. Failure to do this may cause an electric shock.*
2. *To avoid injury, be careful not to pinch your fingers while opening or closing the cover and print head block.*
3. *The print head becomes hot immediately after printing. Allow it to cool before performing any maintenance.*
4. *Do not pour water directly onto the printer.*

This chapter describes how to perform routine maintenance.

To ensure the continuous high quality operation of the printer, you should perform a regular maintenance routine. For high usage it should be done on a daily basis. For low usage it should be done on a weekly basis.

### 4.1 Cleaning

To maintain the printer performance and print quality, please clean the printer regularly, or whenever the media or ribbon is replaced.

#### 4.1.1 Print Head/Platen/Sensors

### **CAUTION!**

1. *Do not use any volatile solvent including thinner and benzene, as this may cause discoloration to the cover, print failure, or breakdown of the printer.*
2. *Do not touch the Print Head Element with bare hands, as static may damage the Print Head.*

1. Turn off the power and unplug the printer.
2. Open the Top Cover.
3. Turn the Head Lever to the “**FREE**” position, and then release the Print Head Block Holder Plate.
4. Open the Print Head Block.
5. Remove the ribbon and media.

### **CAUTION!**

*When cleaning the print head, be careful not to damage the print head with hard objects like watches or rings.*



Care must be taken not to allow the metal or glass part of a watch to touch the print head edge.

Care must be taken not to allow a metal object like a ring to touch the print head edge.

Since the print head element can be easily damaged by shock, please treat it carefully and do not hit it with hard objects.

### 4.1.1 Print Head/Platen/Sensors (Cont.)

**NOTE:**

Please purchase the Print Head Cleaner from your authorised TOSHIBA TEC service representative.

6. Clean the Print Head Element with a Print Head Cleaner or a cotton swab or soft cloth slightly moistened with alcohol.

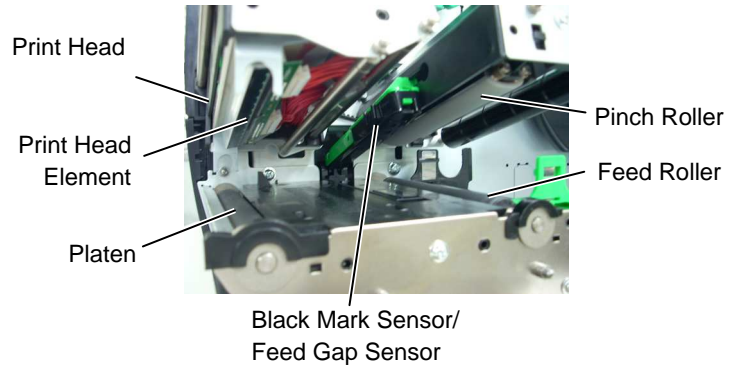

7. Wipe the Platen, Feed Roller, and Pinch Roller with a soft cloth slightly moistened with alcohol. Remove dust or foreign substances from the internal parts of the printer.
8. Wipe the Feed Gap Sensor and Black Mark Sensor with a dry soft cloth.

### 4.1.2 Covers and Panels

**CAUTION!**

1. *DO NOT POUR WATER directly onto the printer.*
2. *DO NOT APPLY cleaner or detergent directly onto any cover or panel.*
3. *NEVER USE THINNER OR OTHER VOLATILE SOLVENT on the plastic covers.*
4. *DO NOT clean the panel, covers, or the supply window with alcohol as it may cause them to discolour, lose their shape or develop structural weakness.*

Wipe the covers and panels with a dry soft cloth or a cloth slightly moistened with a mild detergent solution.



### 4.1.3 Optional Cutter Module

The disc cutter is available as an option.

#### **WARNING!**

1. *Be sure to turn the power off before cleaning the Cutter Module.*
2. *As the cutter blade is sharp, care should be taken not to injure yourself while cleaning.*

1. Turn off the power and open the Top Cover.
2. Turn the Head Lever to Free position, then release the Print Head Block Holder Plate
3. Open the Print Head Block.

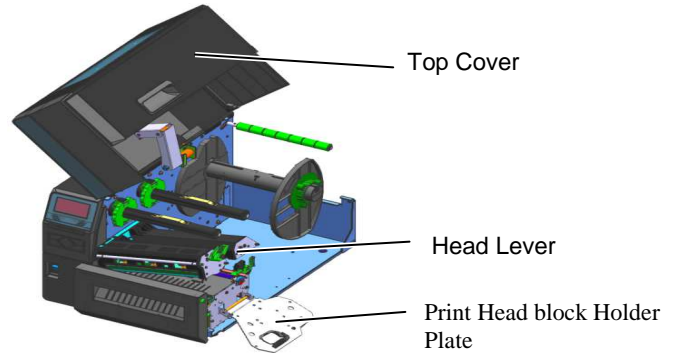

4. Unscrew the Plastic Head Screw so that the Cutter Unit will open

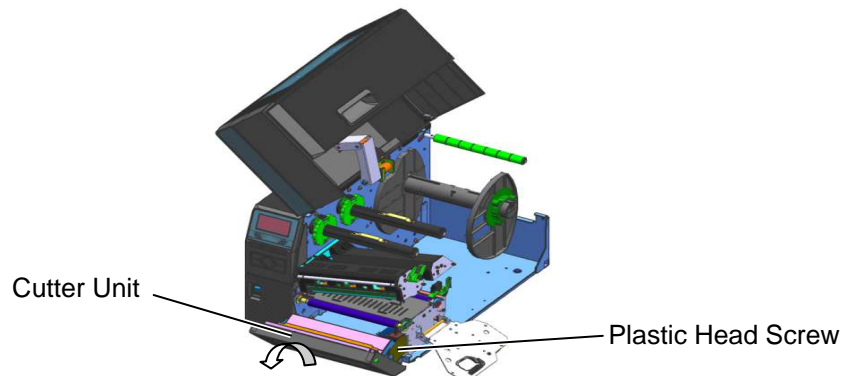

5. Clean the Cutter with a soft cloth slightly moistened with alcohol.
6. Attach the Cutter Cover.

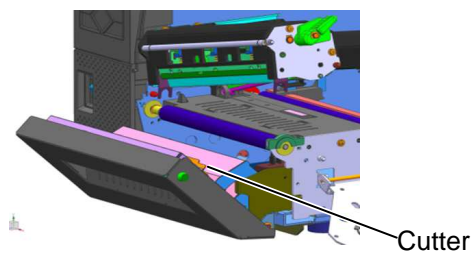

## 5. TROUBLESHOOTING

This chapter lists the error messages, possible problems, and their solutions.

### WARNING!

If a problem cannot be solved by taking the actions described in this chapter, do not attempt to repair the printer. Turn off and unplug the printer, then contact an author TOSHIBA TEC service representative for assistance.

### 5.1 Error Messages

#### NOTES:

- If an error is not cleared by pressing the **[RESTART]** key, turn the printer off and then on.
- After the printer is turned off, all print data in the printer is cleared.

Error Messages	Problems/Causes	Solutions
<b>HEAD OPEN</b>	The Print Head Block is opened in Online mode.	Close the Print Head Block.
	Feeding or printing has been attempted with the Print Head Block open.	Close the Print Head Block. Then press the <b>[RESTART]</b> key.
<b>COMMS ERROR</b>	A communication error has occurred.	Make sure the interface cable is correctly connected to the printer and the host and the host is turned on.
<b>PAPER JAM</b>	1. The media is jammed in the media path. The media is not fed smoothly.	1. Remove the jammed media, and clean the Platen. Reload the media correctly. Press the <b>[RESTART]</b> key. ⇒ <b>Section 5.3.</b>
	2. The media is not loaded properly.	2. Reload the media correctly. Then press the <b>[RESTART]</b> key. ⇒ <b>Section 2.3.</b>
	3. Wrong Media Sensor is selected for the media being used.	3. Turn the printer off and then on. Select the Media Sensor for the media type being used. Resend the print job.
	4. The Black Mark Sensor is not correctly aligned with the Black Mark on the media.	4. Adjust the sensor position, then press the <b>[RESTART]</b> key. ⇒ <b>Section 2.3.1.</b>
	5. Size of the loaded media is different from the programmed size.	5. Replace the loaded media with one that matches the programmed size, press the <b>[RESTART]</b> key, or turn the printer off and then on, select a programmed size that matches the loaded media. Resend the print job.
	6. Media sensor has not been properly calibrated for the media being used.	6. Refer to <b>Section 2.10</b> to set the threshold. If this does not solve the problem, turn off the printer, and call a TOSHIBA TEC authorised service representative.



## 5.1 Error Messages (Cont.)

Error Messages	Problems/Cause	Solutions
<b>CUTTER ERROR</b> (Only when the cutter module is installed on the printer.)	1. The media is jammed in the cutter.	1. Remove the jammed media. Press the <b>[RESTART]</b> key. If this does not solve the problem, turn off the printer, and call a TOSHIBA TEC authorised service representative. ⇒ <b>Section 4.1.3.</b>
	2. The Cutter Cover is not attached properly.	2. Attach the Cutter Cover properly.
<b>NO PAPER</b>	1. The media has run out.	1. Load new media. Press the <b>[RESTART]</b> key. ⇒ <b>Section 2.3.1.</b>
	2. The media is not loaded properly.	2. Reload the media correctly. Press the <b>[RESTART]</b> key. ⇒ <b>Section 2.3.1.</b>
	3. The media sensor position has not been adjusted properly.	3. Adjust the sensor position. Press the <b>[RESTART]</b> key. ⇒ <b>Section 2.3.1.</b>
	4. Media sensor has not been properly calibrated for the media being used.	4. Refer to <b>Section 2.10</b> to set the threshold. If this does not solve the problem, turn off the printer, and call a TOSHIBA TEC authorised service representative.
	5. The media is slack.	5. Take up any slack in the media.
<b>RIBBON ERROR</b>	1. The ribbon is not fed properly.	1. Remove the ribbon and check the status of the ribbon. Replace the ribbon if necessary. If the problem is not solved, turn off the printer, and call a TOSHIBA TEC authorised service representative.
	2. The ribbon is not loaded.	2. Load a ribbon. ⇒ <b>Section 2.3.2</b>
	3. The ribbon sensor has a problem.	3. Turn off the printer and call a TOSHIBA TEC authorised service representative.
<b>NO RIBBON</b>	The ribbon has run out.	Load a new ribbon. Press the <b>[RESTART]</b> key. ⇒ <b>Section 2.3.2.</b>
<b>REWIND FULL</b>	The Built-in Rewinder Unit is full.	Remove the backing paper from the Built-In Rewinder Unit. Press the <b>[RESTART]</b> key.
<b>EXCESS HEAD TEMP</b>	The Print Head has overheated.	Turn off the printer and allow it to cool down for about 3 minutes. If this does not solve the problem call a TOSHIBA TEC authorised service representative.
<b>HEAD ERROR</b>	There is a problem with the Print Head.	Replace the Print Head.
<b>POWER FAILURE</b>	A momentary power failure has occurred.	Check that the power source, which supplies power to the printer, is the correct rating. If the printer shares the same power outlet with other electrical appliances that consume large amounts of power, use a different outlet.

## 5.1 Error Messages (Cont.)

Error Messages	Problems/Cause	Solutions
<b>SYSTEM ERROR</b>	1. The printer is used in a location where it is subject to noise or there are power cords from other electrical appliances near the printer or interface cables.	1. Keep the printer and the interface cables away from the source of noise
	2. The Power Cord of the printer is not grounded.	2. Ground the Power Cord.
	3. The printer shares the same power source with any other electrical appliances.	3. Provide an exclusive power source for the printer.
	4. An application software used on your host computer has an error or malfunction.	4. Confirm the host computer operates properly.
<b>MEMORY WRITE ERR.</b>	An error has occurred in writing to the flash ROM/USB memory.	Turn the printer off, and then on again.
<b>FORMAT ERROR</b>	An error has occurred in formatting the flash ROM/USB memory.	Turn the printer off, and then on again.
<b>MEMORY FULL</b>	Saving failed because of insufficient storage space in the flash ROM/USB memory.	Turn the printer off, and then on again.
<b>EEPROM ERROR</b>	Data cannot be read-from or written-to a backup EEPROM properly.	Turn the printer off, and then on again.
<b>RFID WRITE ERROR</b>	The printer did not succeed in writing data onto an RFID tag after retrying the specified number of times.	Press the <b>[RESTART]</b> key.
<b>RFID ERROR</b>	The printer cannot communicate with the RFID module.	Turn the printer off, and then on again.
<b>LOW BATTERY</b>	The voltage of the Real Time Clock Battery is low.	If you wish to keep using the same battery even after "LOW BATTERY" error occurs, turn off the printer and start it in the system mode, set the date and time for the RTC and reset the printer. As long as the power is on the date and time will be correct. Call a TOSHIBA TEC authorised service representative to replace the battery.
<b>SYNTAX ERROR</b>	While the printer is in the Download mode for upgrading the firmware, it receives an improper command, for example, an Issue Command.	Turn the printer off, and then on again.
<b>PASSWORD INVALID Please Power OFF</b>	A wrong password was entered three consecutive times.	Please consult the system administrator.
Other error messages	A hardware or software problem may have occurred.	Turn the printer off and then on. If this does not solve the problem, turn off the printer, and call a TOSHIBA TEC authorised service representative.

## 5.2 Possible Problems

This section describes problems that may occur when using the printer, and their causes and solutions.

Possible Problems	Causes	Solutions
The printer will not turn on.	1. The Power Cord is disconnected.	1. Plug in the Power Cord.
	2. The AC outlet is not functioning correctly.	2. Test with a power cord from another electrical appliance.
	3. The fuse has blown, or the circuit breaker has tripped.	3. Check the fuse or circuit breaker.
The media will not feed.	1. The media is not loaded properly.	1. Load the media properly. ⇒ <b>Section 2.3.1.</b>
	2. The printer is in an error condition.	2. Solve the error in the message display. (See <b>Section 5.1</b> for more detail.)
Pressing the <b>[FEED]</b> key in the initial state results in an error.	A feed was attempted contrary to the following default conditions. Sensor type: Feed gap sensor Printing method: Thermal transfer Media pitch: 76.2 mm	Change the print condition by using the printer driver or a print command so that it corresponds to your printing conditions. Clear the error state by pressing the <b>[RESTART]</b> key.
Nothing is printed on the media.	1. The media is not loaded properly.	1. Load the media properly. ⇒ <b>Section 2.3.1.</b>
	2. The ribbon is not loaded properly.	2. Load the ribbon properly. ⇒ <b>Section 2.3.2.</b>
	3. The print head is not installed properly.	3. Install the print head properly and close the Print Head Block.
	4. The combination of the ribbon and media is not correct.	4. Select an appropriate ribbon for the media type being used.
The printed image is blurred.	1. The combination of the ribbon and media is not correct.	1. Select an appropriate ribbon for the media type being used.
	2. The Print Head is not clean.	2. Clean the print head using the Print Head Cleaner or a cotton swab slightly moistened with ethyl alcohol.
The cutter does not cut.	1. The Cutter Cover is not attached properly.	1. Attach the Cutter Cover properly.
	2. The media is jammed in the Cutter.	2. Remove the jammed paper. ⇒ <b>Section 4.1.3.</b>
	3. The cutter blade is dirty.	3. Clean the cutter blade. ⇒ <b>Section 4.1.3.</b>
The Strip Module does not remove labels from the backing paper.	Label stock is too thin or the glue is too sticky.	1. Refer to <b>Section 7.1 Media</b> and change the label.
		2. Set the Pre Peel function to ON. ⇒ <b>Section 2.6.2.</b>

### 5.3 Removing Jammed Media

This section describes, in detail, how to remove jammed media from the printer.

**CAUTION!**  
Do not use any tool that may damage the Print Head.

1. Open the Top Cover.
2. Turn the Head Lever to **FREE** position, then open the Print Head Block Holder Plate.
3. Open the Print Head Block.
4. Remove the ribbon and media.

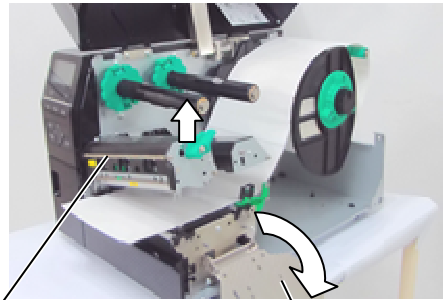

Print Head Block

Print Head Block Holder Plate

5. Remove the jammed media from the printer. **DO NOT** use any sharp implements or tools as these could damage the printer.
6. Clean the Print Head and Platen, then remove any further dust or foreign substances.
7. Paper jams in the Cutter Unit can be caused by wear or residual glue from label stock on the cutter. Do not use non-specified media in the cutter.

**NOTE:**  
*If you get frequent jams in the cutter, contact a TOSHIBA TEC authorized service representative.*

**CAUTION!**

*When removing the jammed media, be careful not to damage the print head with hard objects like watches or rings.*

Care must be taken not to allow the metal or glass part of a watch to touch the print head.

Care must be taken not to allow a metal object like a ring to touch the print head.

*Since the print head element can be easily damaged by shock, please treat it carefully and do not hit it with hard objects.*

## 6. PRINTER SPECIFICATIONS

This section describes the printer specifications.

<b>Model</b>		<b>B-EX6T1/T3-GS</b>	<b>B-EX6T1/T3-TS</b>
Destination	QM: World wide	B-EX6T1/T3-GS12-QM-R	B-EX6T1/T3-TS12-QM-R
	CN: China	B-EX6T1/T3-GS12-CN-R	B-EX6T1/T3-TS12-CN-R
Dimension (W x D x H)		331 mm x 460 mm x 310 mm	
Weight (kg)		20 kg	
Operating temperature range		5 degC to 40 degC (40 degF to 104 degF)	
Relative humidity		25% to 85% RH (no condensation)	
Power supply		Universal switching power source AC 100 V to 240 V, 50/60 Hz +/- 10%	
Input voltage		AC100 V to 240 V, 50/60 Hz +/- 10%	
Power	During a print job*	210W 2.4A - 0.95A	
Consumption	During stand-by	15W or less	
	During sleep mode	5.7W 0.09A	
Resolution		8 dots/mm (203 dpi)	12 dots/mm (305 dpi)
Printing method		Thermal transfer or Direct Transfer	
Printing speed		76.2 mm/sec. (3 inches/sec.) 127.0 mm/sec. (5 inches/sec.) 203.0 mm/sec. (8 inches/sec.) 254.0 mm/sec. (10 inches/sec.) 304.8 mm/sec. (12 inches/sec.)	
Available media width (including backing paper)		50mm to 165mm	
Effective print width (max.)		160.0 mm (203DPI), 159.9 mm (305DPI)	
Issue mode		Batch Peel Off (Strip mode is enabled only when the optional Strip Module is installed.) Cut (Cut mode is enabled only when the optional Cutter Module is installed.)	
LCD Message display		Graphic type 128 x 64 dots or more, with back light	

\*: While 15% slant lines are printed in the specified format.

<b>Model</b>		<b>B-EX6T1/T3-GS</b>	<b>B-EX6T1/T3-TS</b>
<b>Item</b>			
Bar code types		JAN/EAN/UPC, CODE128, CODE93, CODE39(S, F,) MSI, Interleaved 2 of 5, Customer bar code, GS1 DataBar (including composite)	
Two-dimensional code		Data Matrix, PDF417, Micro PDF417, QR code, MaxiCode, CP code, Micro QR code	
Font	Bitmap	Bitmap font: 21 types (Standard)	
	Japanese Kanji	Japanese Kanji: 4 types of Square Gothic, 2 types of Mincho (Standard),	
	Chinese character	Chinese character: (Standard)	
	Outline font	Outline font: 8 types (Standard)	
	Writable character	Writable character	
	True Type Font	TrueType font	
	Other fonts	Unicode (UTF-32) support Support OTF font (Chinese , Korea , Japanese, Turkish, Thai , Slab, Greek as standard )	
	Bitmap	Bitmap font: 21 types (Standard)	
Rotations		0, 90, 180, 270 deg angle	
Standard interface	USB	Standard: 1.1 Full speed	
	LAN	Standard: 10 BASE / 100 BASE, IPV6	
	Centronics	Option	
	RS-232C	Option	
	Parallel I/F	Option	
	WLAN	Option 802.11b,g,n	
	Bluetooth I/F	None	
	Expansion I/O	Option	
	RTC	Standard	
	Ribbon save module	Standard (T1) None (T3)	
	USB host	Standard: 1.1 Full speed Front	
	NFC	None	
RFID		RFID GS/TS18 : EPC UHF Gen2, ISO-18000-6C	
Optional Module		Disc cutter module (B-EX206-QM-R) Strip module (B-EX906-H-QM-R) RFID module (B-EX706-RFID-U4-US-R, B-EX706-RFID-U4-EU-R, B-EX706-RFID-U4-AU-R)	

**NOTES:**

- *Data Matrix™ is a trademark of International Data Matrix Inc., U.S.*
- *PDF417™ is a trademark of Symbol Technologies Inc., US.*
- *QR Code is a trademark of DENSO CORPORATION.*
- *Maxi Code is a trademark of United Parcel Service of America, Inc., U.S.*

## 7. SUPPLY SPECIFICATIONS

### 7.1 Media

Please make sure that the media being used is approved by TOSHIBA TEC. The warranty does not apply when a problem is caused by using media that is not approved by TOSHIBA TEC.

For information regarding TOSHIBA TEC approved media, please contact a TOSHIBA TEC authorized service representative.

#### 7.1.1 Media Type

Two types of media can be loaded for this thermal transfer and direct thermal printer: label or tag. The table below shows size and shape of the media available for this printer.

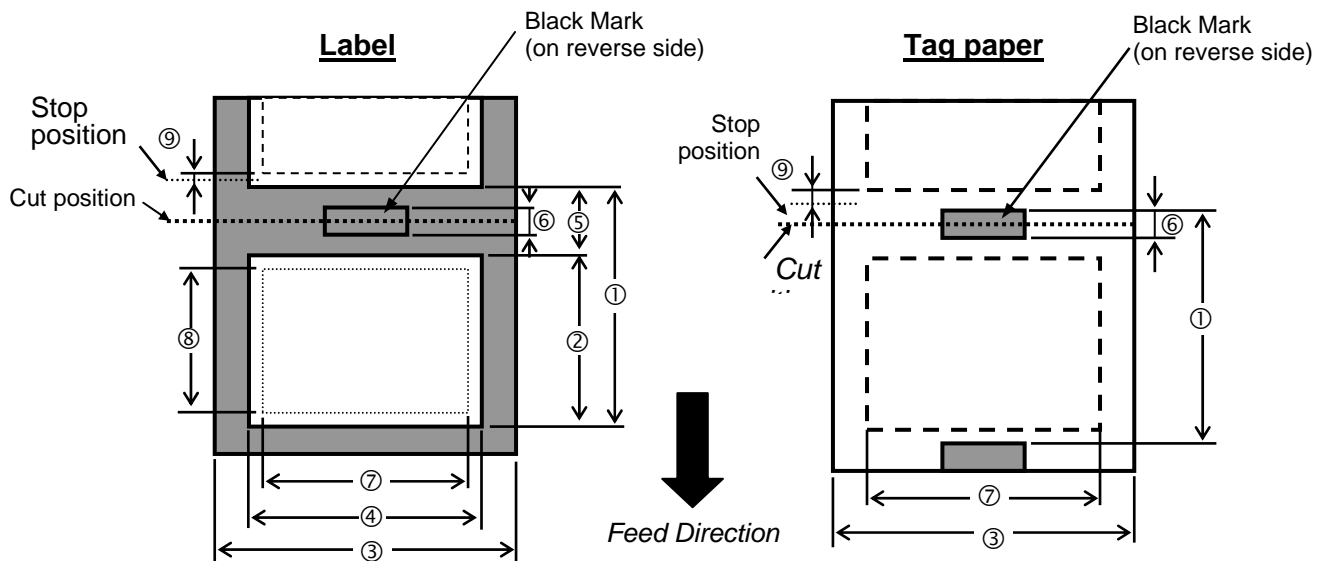

		B-EX6T Type1 and Type3		
		Batch	Cutter	Peel-off
Pitch	Min.	10mm	26.4mm	25.4mm
	Max.	1500mm	1500mm	256mm
label Length	Min.	8mm	20.4mm	23.4mm
	Max.	1498mm	1494mm	254mm
Width (Backing paper width)	Min.	50mm	50mm	50mm
	Max.	165mm	165mm	165mm
Gap	Min.	2mm	6mm	2mm
	Max.	20mm	20mm	20mm
Black mark length	Min.	2mm	2mm	2mm
	Max.	10mm	10mm	10mm
Thickness of tag paper or backing paper that can be cut	Min.	-	0.08mm	-
	Max.	-	0.17mm	-
Min. cut length		-	25.4mm	-



Max. outer roll diameter		Φ200mm		
Thickness		Label 0.13 to 0.17mm Tag 0.15 to 0.25mm	Label 0.13 to 0.17mm Tag 0.15 to 0.17mm	Label 0.13 to 0.17mm
Roll-up method		Inner ·Outer		
Paper core		ID φ76.2±0.3mm		

**NOTES:**

1. To ensure print quality and print head life use only TOSHIBA TEC specified media.
2. When using the peel-off at 12"/sec or more for 203dpi model, issue at 10"/sec.  
When using the peel-off at 10"/sec or more for 305dpi model, issue at 8"/sec.
3. When the Disc cutter is used, the minimum label length shall be 18.0 mm – (Gap length/2) or longer.
4. The ratio of a label length to a gap length must be a minimum of 3 to 1 (3:1).
5. When using label stock in cut mode, be sure to cut in the gaps. Cutting labels will cause the adhesive to stick to the cutter, which may affect the cutter performance and shorten the cutter life.

**7.1.2 Detection Area of the Transmissive Sensor**

The Transmissive Sensor is movable from the centre to the left edge of media.  
 The Transmissive Sensor detects a gap between labels, as illustrated below.

<Tags>

Detection of hole

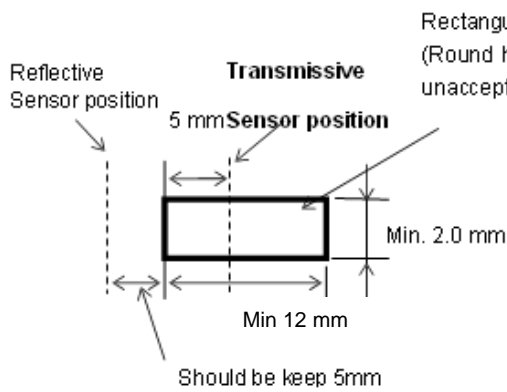

**Magnified view of detection area**

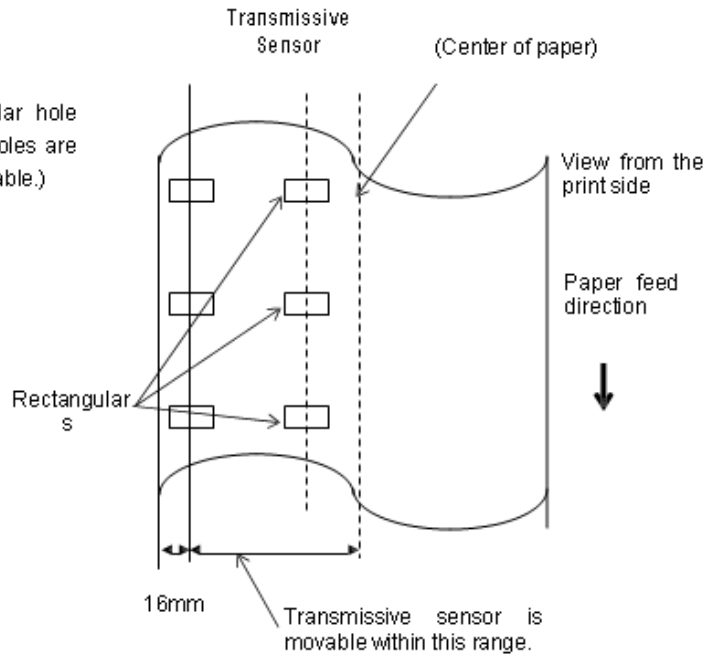

<Labels>

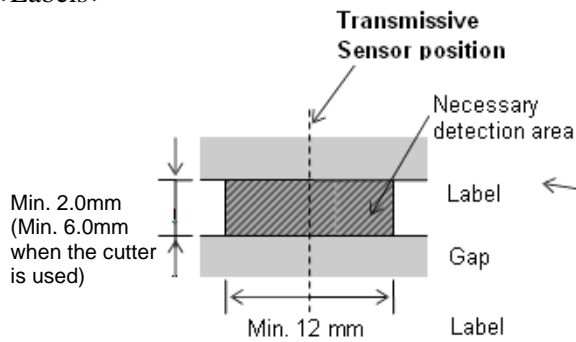

**Magnified view of detection area**

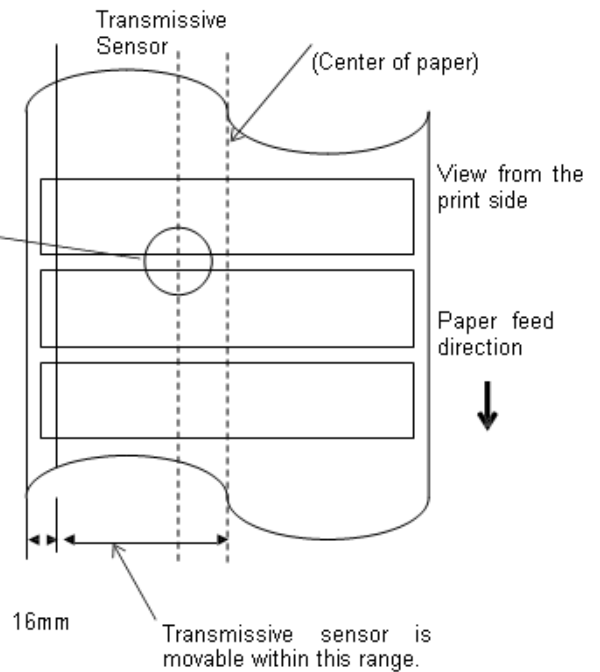

**NOTE:**  
 Round holes are not acceptable.

### 7.1.3 Detection Area of the Reflective Sensor

1. The sensor is movable in the range from the center of the paper to the left end.
2. The reflectance of the black mark must be 10% or less with a waveform length of 950 nm.
3. The sensor detects at the center of the black mark.
4. The black marks, if necessary, must be printed on the labels in the gap areas.
5. Rectangular holes can substitute the black marks, on the condition that nothing is printed on the back side. Round holes cannot be detected by the reflective sensor.

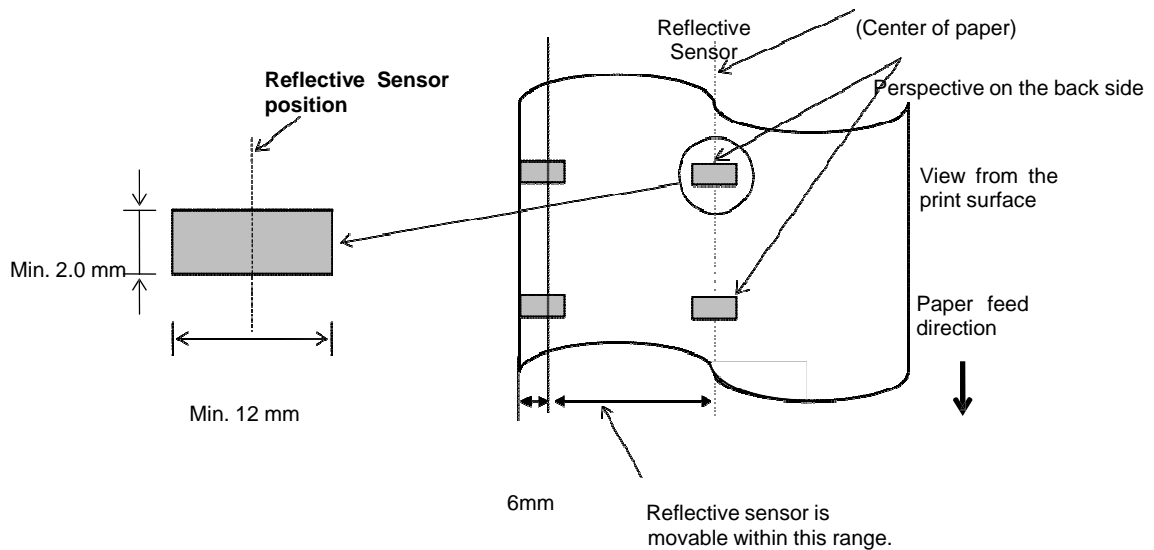

**7.1.4 EFFECTIVE PRINT AREA OF PAPER**

**7.1.4.1 Relationship between Print Head Effective Print Width and Paper Width**

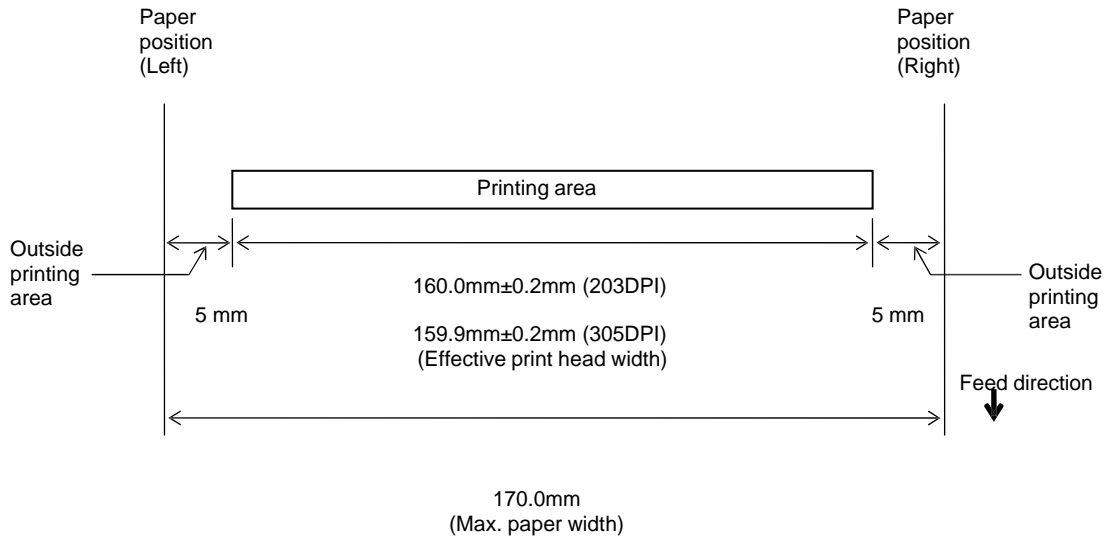

**7.1.4.2 Effective Print Area of Tags and Labels**

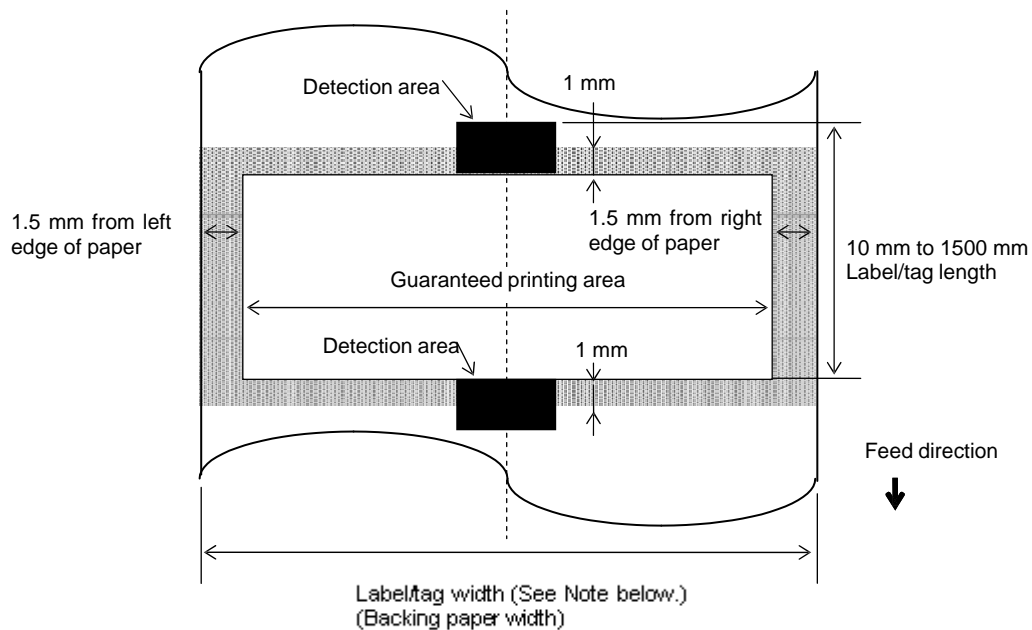

**NOTES:**

1. *Print quality in the shaded area is not guaranteed. For the label, printing in the 1-mm width area around the label is not guaranteed as well as the shaded area shown above.*
2. *The center of the paper (label and tag) is almost aligned with the center of the print head.*
3. *If printing is performed in the shaded area, the ribbon may wrinkle. This may affect the print quality of the guaranteed printing area.*

## 7.2 Ribbon

Please make sure that the ribbon being used is approved by TOSHIBA TEC. The warranty does not apply to any problem caused by using non-approved ribbons.

For information regarding TOSHIBA TEC approved ribbon, please contact a TOSHIBA TEC service representative.

	B-EX6T Type1	B-EX6T Type3
Ribbon Width	55mm to 170mm	
Max Ribbon Length	600m *Using AG6E ribbon:800m.	
Max Ribbon OD	φ90mm	
Ribbon Core	Inside 25.7± 0.2mm	
Type	Ribbon for edge head	Ribbon for flat head
Ribbon winding	Outside	

The table below shows the correlation between ribbon width and media width (backing paper is not included.)

Ribbon width	Media width	Ribbon width	Media width	Ribbon width	Media width
55 mm	50 mm	102 mm	80 – 97 mm	170 mm	130 – 165 mm
68 mm	51 – 63 mm	112 mm	98 – 107 mm		
76 mm	64 – 63 mm	114 mm	98 – 109 mm		
84 mm	64 – 79 mm	134 mm	108 – 129 mm		

### NOTES:

1. To ensure print quality and print head life use only TOSHIBA TEC specified ribbons.
2. To avoid ribbon wrinkles use a ribbon that is wider than the media by 5 mm or more. However, too much difference in width between the two may cause wrinkles.

## 7.3 Recommended Media and Ribbon Types

Media type	Description
Vellum paper and labels	General use for low cost applications.
Coated paper	Matt coated paper General use including applications that require small letters and/or symbols. Glossy coated paper Used where a high-grade finish is required
Plastic films	Synthetic film (Polypropylene, etc.) This water-proof and solvent-resistant material has high physical strength and low-temperature resistance, but poor heat resistance (dependant upon material). This material can be used for labels stuck to recyclable containers, so it can be recycled in the same process. PET film This water-proof and solvent-resistant material has high physical strength, and low-temperature resistance as well as heat resistance. This material is used for many applications, especially where high durability is required. Mode/serial plate labels, caution labels, etc. Polyimide This material gives the best performance on heat resistance (greater than PET film). It is often used for PCB labels as it can withstand passage through a solder bath.

### 7.3 Recommended Media and Ribbon Types (Cont.)

Ribbon type	Description
Smear-less ribbon (Wax resin ribbon)	Good match for coated paper. The printed image will resist water and light rubbing.
Scratch and solvent resistance ribbon	Very good match for plastic films (synthetic paper, PET, polyimide, etc.) Scratch and solvent resistance Heat resistance with PET and polyimide.

#### Combination of Media and Ribbon

Media type \ Ribbon type	Vellum paper and label	Coated paper	Plastic films
Smear-less ribbon (wax-resin ribbon)		○	
Scratch/solvent resistance ribbon			○

○: Good match

### 7.4 Care/Handling of Media and Ribbon

#### CAUTION!

*Be sure to carefully review and understand the Supply Manual. Use only media and ribbons that meet specified requirements. Use of non-specified media and ribbons may shorten the head life and result in problems with bar code readability or print quality. All media and ribbons should be handled with care to avoid any damage to the media, ribbons or printer. Read the guidelines in this section carefully.*

- Do not store the media or ribbon for longer than the manufacturer's recommended shelf life.
- Store media rolls on the flat end. Do not store them on the curved sides as this might flatten that side causing erratic media advance and poor print quality.
- Store the media in plastic bags and always reseal after opening. Unprotected media can get dirty and the extra abrasion from the dust and dirt particles will shorten the print head life.
- Store the media and ribbon in a cool, dry place. Avoid areas where they would be exposed to direct sunlight, high temperature, high humidity, dust or gas.
- The thermal paper used for direct thermal printing must not have specifications which exceed Na<sup>+</sup> 800 ppm, K<sup>+</sup> 250 ppm and Cl<sup>-</sup> 500 ppm.
- Some ink used on pre-printed media may contain ingredients which shorten the print head's product life. Do not use labels pre-printed with ink which contain hard substances such as carbonic calcium (CaCO<sub>3</sub>) and kaolin (Al<sub>2</sub>O<sub>3</sub>, 2SiO<sub>2</sub>, 2H<sub>2</sub>O).

For further information, please contact your local distributor or your media and ribbon manufacturers.

## APPENDIX 1 MESSAGES AND LEDS

Appendix 1 describes the LCD messages displayed on the operation panel.

### Symbols in the message

1: ○: The LED is illuminated. ⊙: The LED is flashing. ●: The LED is unlit.

2: %,%%,%%%,%%%: Remaining memory size of the external memory: 0 to 09,999,999 (in K bytes)

3: ####: Remaining memory size for PC commands storage area in the internal memory: 0 to 3072 (in K bytes)

4: &&&&: Remaining memory size for writable characters storage area: 0 to 3147 (in K bytes)

No.	LCD Message	LED Indication		Printer Status	Restoration by RESTART key Yes/No	Acceptance of Status Request/Reset Command Yes/No
		ONLINE	ERROR			
1	ON LINE	○	●	In online mode	----	Yes
	ON LINE	⊙	●	In online mode (The printer is communicating)	----	Yes
2	HEAD OPEN	●	●	The print head block is open in online mode.	----	Yes
3	PAUSE	●	●	The printer is paused.	Yes	Yes
4	COMMS ERROR	●	○	A parity, overrun, or framing error has occurred during communication through the RS-232C.	Yes	Yes
5	PAPER JAM	●	○	The media has jammed during paper feed.	Yes	Yes
6	CUTTER ERROR	●	○	A problem has occurred with the cutter module.	Yes	Yes
7	NO PAPER	●	○	The media has run out, or the media is not loaded properly.	Yes	Yes
8	NO RIBBON	●	○	The ribbon has run out.	Yes	Yes
9	HEAD OPEN	●	○	Feed or printing was attempted with the print head block open.	Yes	Yes
10	HEAD ERROR	●	○	There is a problem with the print head.	Yes	Yes
11	EXCESS HEAD TEMP	●	○	The print head has overheated.	No	Yes
12	RIBBON ERROR	●	○	The ribbon has been torn. A problem has occurred with the sensor that determines the torque for the ribbon motor.	Yes	Yes
13	REWIND FULL	●	○	The internal rewind unit is full.	Yes	Yes
14	SAVING#####KB/&&&&KB or SAVING%,%%%,%%%,%%%KB	○	●	Writable character or PC command save mode	----	Yes
15	FORMAT#####KB/&&&&KB or FORMAT%,%%%,%%%,%%%KB	○	●	The storage area is being initialised.	----	Yes
16	NOW LOADING...	○	●	TrueType font or BASIC program is being downloaded.	----	Yes
17	MEMORY WRITE ERR.	●	○	An error has occurred while writing to flash memory or USB memory.	No	Yes
18	FORMAT ERROR	●	○	An erase error has occurred while formatting the flash memory or USB memory.	No	Yes
19	MEMORY FULL	●	○	Data cannot be stored because the flash memory or USB memory is full.	No	Yes
20	SYNTAX ERROR (Refer to "Notes")	●	○	A command error has occurred while analyzing the command.	Yes	Yes
21	POWER FAILURE	●	○	A power failure has occurred.	No	No

22	EEPROM ERROR	●	○	Data cannot be read from/written to a backup EEPROM properly	No	No
23	SYSTEM ERROR	●	○	When the following abnormal operations are performed, a system error occurs: (a) Command fetch from an incorrect address. (b) Access to word data at an incorrect address. (c) Access to long-word data at an incorrect address. (d) Access to the area of 80000000H to FFFFFFFFH in the logic space in user mode. (e) An undefined instruction in an area other than a delay slot was decoded. (f) An undefined instruction in a delay slot was decoded. (g) An instruction to rewrite a delay slot was decoded.	No	No
24	DHCP CLIENT INIT...	●	●	DHCP Client is being initialised. (Only when the DHCP is enabled.)	----	----
25	RFID WRITE ERROR	●	○	The printer did not succeed in writing data onto an RFID tag after having retried the specified number of times.	Yes	Yes
26	RFID ERROR	●	○	The printer cannot communicate with the RFID module.	No	Yes
27	INPUT PASSWORD	●	●	The printer is waiting for a password to be entered.	No	No
28	PASSWORD INVALID	●	●	A wrong password was entered three consecutive times.	No	No
29	RFID CONFIG ERROR	●	○	B-EX700-RFID-U2-EU/US-R, B-EX700-RFID-U4-EU/US-R, U4 Module preinstall model only RFID Module's destination code is not specified.	No	No
30	LOW BATTERY ( Refer to Notes)	●	○	RTC Battery is low.	No	Yes
31	INTERNAL COM ERR	●	●	A hardware error has occurred in the internal serial interface.	No	No

**NOTE:** When an error message listed above appears on the LCD display please refer to **Section 5 TROUBLESHOOTING** for a solution.



**NOTES:**

- If an error is found in a command received, up to 42 bytes of the erroneous command, starting from the command code, will be displayed. (However, [LF] and [NUL] will not be displayed.)

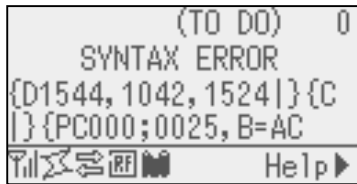

## Example 1

[ESC]PC001;0A00,0300,2,2,A,00,B[LF][NUL]

└─ Command error

The following message appears.

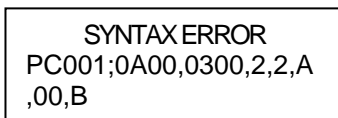

## Example 2

[ESC]T20G30[LF] [NUL]

└─ Command error

The following message appears.

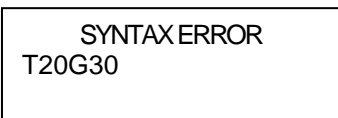

## Example 3

[ESC]PC002;0100,0300,15,15,A,00,00,J0101,+000000000A,Z10,P1[LF] [NUL]

└─ Command error

The following message appears.

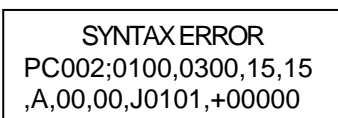

- When the error is shown, “? (3FH)” appears for character codes other than 20H to 7FH and A0H to DFH.
- For details, please refer to the **B-EX4/EX6 Series External Equipment Interface Specification**.

**NOTES:**

- The battery check does not work when the printer is being reset and the RTC is not mounted.
  - It is necessary to follow the procedure below to use RTC function under a low battery condition.
  - Turn off the printer power while the printer is in an error state. Start the printer in the system mode, set the date and time for the RTC again, then reset the printer to place the printer in online state.
- \* The printer can print the programmed date and time until it is turned off.

# APPENDIX 2 INTERFACE

**NOTE:**

To prevent radiation and reception of electrical noise, the interface cables must meet the following requirements:

- In case of a parallel interface cable or serial interface cable, fully shielded and fitted with metal or metallised connector housings.
  - Keep as short as possible.
  - Should not be bundled tightly with power cords.
  - Should not be tied to power line conduits.

## ■ USB interface (Standard)

Physical Layer: Conforming to V2.0 Full speed  
 Transfer type: Control transfer, Bulk transfer  
 Transfer rate: Full speed (12M bps)  
 Class: Printer class  
 Number of ports: 1  
 Power source: Self power  
 Connector: Type B

Pin No.	Signal
1	VCC
2	D-
3	D+
4	GND

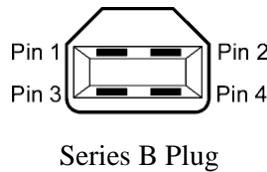

## ■ LAN (Standard)

Physical Layer: IEEE802.3 10BASE-T/100BASE-TX  
 Number of ports: 1  
 Connector: RJ-45  
 LED status: Link LED, Activity LED

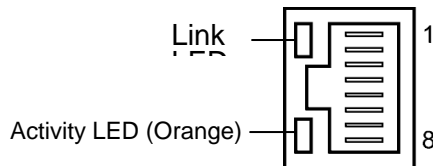

LED	LED Status	LAN status
Link	ON	10Mbps link or 100Mbps link is detected.
	OFF	No link is detected. * Communication cannot be made while the Link LED is off.
Activity	ON	Communicating
	OFF	Idle

LAN cable: 10BASE-T: UTP category 3 or category 5  
 100BASE-TX: UTP category 5  
 Cable length: Segment length Max. 100 m

**NOTE:**

When a generally-used twisted pair Ethernet (TPE) or UTP cable is used, communication errors may occur subject to your operating environment. In such a case, please use a shielded twisted pair cable.

### ■ Serial interface (Option: B-EX700-RS-QM-R)

Type:	RS-232C
Communication mode:	Full duplex
Transmission speed:	2400 bps, 4800 bps, 9600 bps, 19200 bps, 38400 bps, 115200 bps
Synchronization:	Start-stop synchronization
Start bit:	1 bit
Stop bit:	1 bit, 2 bit
Data length:	7 bit, 8 bit
Parity:	None, EVEN, ODD
Error detection:	Parity error, Framing error, Overrun error
Protocol:	Unprocedure communication
Data input code:	ASCII code, European character 8 bit code, graphic 8 bit code, JIS8 code, Shift JIS Kanji code, JIS Kanji code
Receive buffer:	1M byte
Connector:	

Pin No.	Signal
1	N.C
2	TXD (Transmit Data)
3	RXD (Received Data)
4	DSR (Data Set Ready)
5	SG (Signal Ground)
6	DTR (Data Terminal Ready)
7	CTS (Clear to Send)
8	RTS (Request to Send)
9	N.C

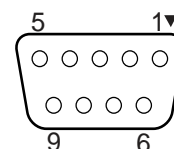

### ■ Parallel interface (Centronics) (Option: B-EX700-CEN-QM-R)

Mode:	Conforming to IEEE1284 Compatible mode (SPP mode), Nibble mode
Data input method:	8 bit parallel
Control signal:	

	SPP Mode	Nibble Mode	ECP Mode
nStrobe		HostClk	HostClk
nAck		PtrClk	PeriphClk
Busy		PtrBusy	PeriphAck
Perror		AckDataReq	NAckReverse
Select		Xflag	Xflag
nAutoFd		HostBusy	HostAck
nInit		nInit	nReverseRequest
nFault		nDataAvail	nPeriphRequest
nSelectIn		IEEE1284Active	IEEE1284Active

Data input code:	ASCII code European 8 bit code Graphic 8 bit code JIS8 code Shift JIS Kanji code JIS Kanji code
Receive buffer:	1MB

Connector:

PIN No.	SPP Mode	Nibble Mode
1	nStrobe	HostClk
2	Data 1	Data 1
3	Data 2	Data 2
4	Data 3	Data 3
5	Data 4	Data 4
6	Data 5	Data 5
7	Data 6	Data 6
8	Data 7	Data 7
9	Data 8	Data 8
10	nAck	PtrClk
11	Busy	PtrBusy
12	PError	AckDataReq
13	Select	Xflag
14	nAutoFd	HostBusy
15	NC	NC
16	0V	0V
17	CHASSIS GND	CHASSIS GND
18	+5V (For detection)	+5V (For detection)
19	TWISTED PAIR GND(PIN1)	TWISTED PAIR GND(PIN1)
20	TWISTED PAIR GND(PIN2)	TWISTED PAIR GND(PIN2)
21	TWISTED PAIR GND(PIN3)	TWISTED PAIR GND(PIN3)
22	TWISTED PAIR GND(PIN4)	TWISTED PAIR GND(PIN4)
23	TWISTED PAIR GND(PIN5)	TWISTED PAIR GND(PIN5)
24	TWISTED PAIR GND(PIN6)	TWISTED PAIR GND(PIN6)
25	TWISTED PAIR GND(PIN7)	TWISTED PAIR GND(PIN7)
26	TWISTED PAIR GND(PIN8)	TWISTED PAIR GND(PIN8)
27	TWISTED PAIR GND(PIN9)	TWISTED PAIR GND(PIN9)
28	TWISTED PAIR GND(PIN10)	TWISTED PAIR GND(PIN10)
29	TWISTED PAIR GND(PIN11)	TWISTED PAIR GND(PIN11)
30	TWISTED PAIR GND(PIN31)	TWISTED PAIR GND(PIN31)
31	nInit	nInit
32	nFault	NDataAvail
33	0V	0V
34	NC	NC
35	NC	NC
36	nSelectIn	IEEE1284Active

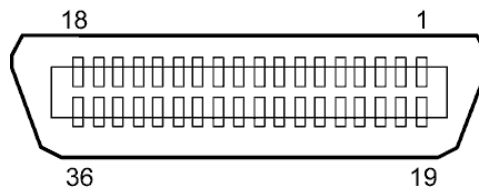

IEEE1284-B Connector

**Wireless LAN (Option: B-EX706-WLAN2-QM-R )**

**Standard: Conforming to IEEE802.11b, and IEEE802.11g, and IEEE802.11n**

Client protocol: TCP/IP, Socket, LPR, DHCP, HTTP

Print protocol: Socket communication/LPR

Security mode: WEP(64 bits) or WPA, WPA2

EAP method: EAP-TLS, PEAP, EAP-TTLS, EAP-FAST

Antenna: Built-in

Parameter setting: via USB, LAN, WLAN, RS-232C

Default IP address: 192.168.10.20

Default subnet mask: 255.255.255.0

***NOTE:***

*MAC address of the Wireless LAN module will be necessary when setting the MAC address filtering function of an access point. Please ask a service person of your nearest TOSHIBA TEC service representative.*

■ Expansion I/O Interface (Option: B-EX700-IO-QM-R)

Input Signal IN0 to IN5  
 Output Signal OUT0 to OUT6  
 Connector (External Device Side) FCN-781P024-G/P or equivalent  
 Connector (Printer Side) FCN-685J0024 or equivalent

Pin	Signal	I/O	Function	Pin	Signal	I/O	Function
1	IN0	Input	FEED	13	OUT6	Output	
2	IN1	Input	PRINT	14	N.C.	----	
3	IN2	Input	PAUSE	15	COM1	Common (Power)	
4	IN3	Input		16	N.C.	----	
5	IN4	Input		17	N.C.	----	
6	IN5	Input		18	N.C.	----	
7	OUT0	Output	FEED	19	N.C.	----	
8	OUT1	Output	PRINT	20	N.C.	----	
9	OUT2	Output	PAUSE	21	COM2	Common (Ground)	
10	OUT3	Output	ERROR	22	N.C.	----	
11	OUT4	Output		23	N.C.	----	
12	OUT5	Output	POWER ON	24	N.C.	----	

N.C.: No Connection

Input Circuit

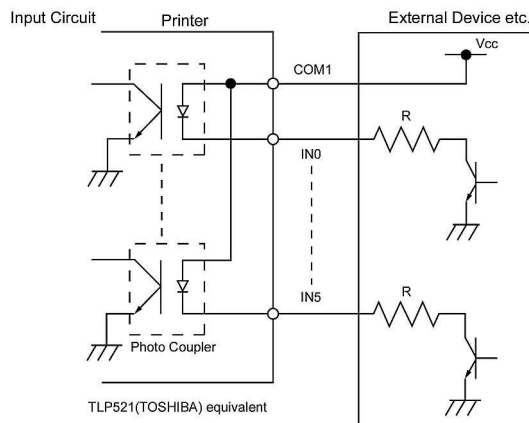

Output Circuit

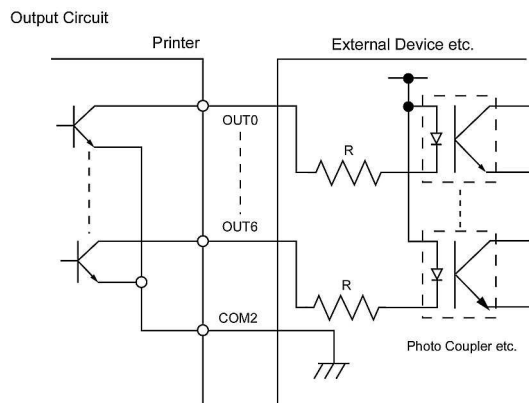

Operating environment Temperature: 0 to 40 °C  
 Humidity: 20 to 90% (No Condensation)

**■ RFID****• (Option)B-EX706-RFID-U4-US-R**

Module: TOSHIBATEC TRW-USM-10  
Frequency: 902.75-927.25Mhz  
Output: 10 to 100 mW  
Available RFID tag: EPC C1 Gen2, ISO-18000-6C

**• (Option)B-EX706-RFID-U4-EU-R**

Module: TOSHIBATEC TRW-EUR-10  
Frequency: 869.85 MHz (UHF Europe)  
Output: 10 to 100 mW  
Available RFID tag: EPC C1 Gen2, ISO-18000-6C

**• (Option) B-EX706-RFID-U4-AU-R**

Module: TOSHIBATECTRW-AUR-10  
Frequency: 918.25-925.75MHz (UHF )  
Output: 10 to 100 mW  
Available RFID tag: EPC C1 Gen2, ISO-18000-6C

## APPENDIX 3 PRINT SAMPLES

### ■ Font

<A>Times Roman medium

<B>Times Roman medium

<C>Times Roman bold

<D>Times Roman bold

<E>Times Roman bold

<F>Times Roman italic

<G>Helvetica medium

<H>Helvetica medium

<I>Helvetica medium

<J>Helvetica bold

<K>Helvetica bold

<L>Helvetica italic

<M>PRESENTATION BOLD

<N>Letter Gothic medium

<O>Prestige Elite medium

<P>Prestige Elite bold

<Q>Courier medium

<R>Courier bold

<S>OCR-A

<T>OCR-B

<q>Gothic 725 Black

<Outline Font:A> H e l v e t i c a   b o l d

<Outline Font:B> Helvetica bold(P)

<Outline Font:E> 0 1 2 3 4 5 6 7 8 9 , y \$

<Outline Font:F> 0 1 2 3 4 5 6 7 8 9 , ¥ \$

<Outline Font:G> 0 1 2 3 4 5 6 7 8 9 , ¥ \$

<Outline Font:H> Dutch 801 bold

<Outline Font:I> Brush 738 regular

<Outline Font:J> Gothic 725 Black



# APPENDIX 3 PRINT SAMPLES (Cont.)

■ Bar codes

JAN8, EAN8



Interleaved 2 of 5



NW7



UPC-E



EAN13+5 digits



CODE39 (Full ASCII)



UPC-E+2 digits



EAN8+2 digits



UPC-A



MSI



CODE39 (Standard)



JAN13, EAN13



EAN13+2 digits



CODE128



CODE93



UPC-E+5 digits



EAN8+5 digits



UPC-A+2 digits



**UPC-A+5 digits**



**UCC/EAN128**



**Industrial 2 of 5**



**POSTNET**



**Customer bar code**



**Customer bar code of high priority**



**KIX Code**



**RM4SCC**



**Data Matrix**



**MicroQR**



**QR code**



**Micro PDF417**



**MaxiCode**

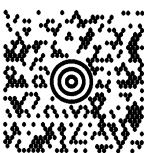

**CP Code**

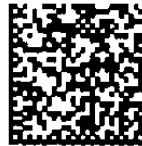

**PDF417**



• **GS1 DataBar family (with no compound composite printed)**

**GS1 DataBar (Truncated)**



**GS1 DataBar Stacked**



**GS1 DataBar Stacked Omnidirectional**



**GS1 DataBar Limited**



**GS1 DataBar Expanded**



**GS1 DataBar Expanded Stacked**

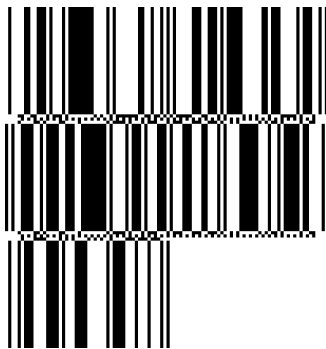

**UPC-A**

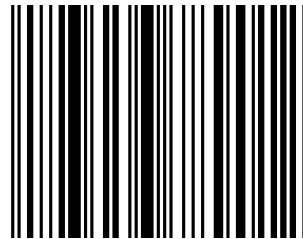

**UPC-E**

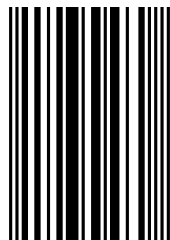

**EAN-13**

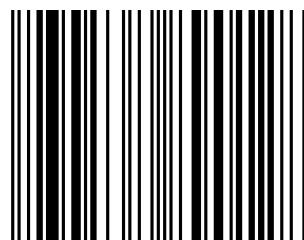

**EAN-8**

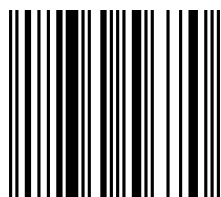

**UCC/EAN-28 with CC-A, CC-B, or CC-C**



• **GS1 DataBar family (with compound composite printed)**

**GS1 DataBar (Truncated)**



**GS1 DataBar Stacked**



**GS1 DataBar Stacked Omnidirectional**



**GS1 DataBar Limited**



**GS1 DataBar Expanded**



**GS1 DataBar Expanded Stacked**

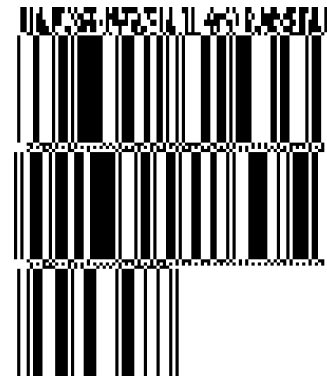

**UPC-A**



**UPC-E**

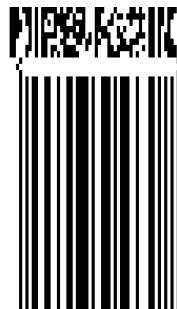

**EAN-8**



**EAN-13**



**UCC/EAN-128 with CC-A or CC-B**



**UCC/EAN-128 with CC-C**



## APPENDIX 4 GLOSSARIES

### **Barcode**

A code which represents alphanumeric characters by using a series of black and white stripes of different widths. Reading barcodes is a fast and accurate means of capturing data.

### **Batch mode**

An issue mode that continuously prints until the specified number has been printed.

### **Black mark**

A black mark printed on the media so that the printer can maintain a consistent print position by detecting this mark.

### **Black mark sensor**

A reflective sensor that detects the difference of potential between the black mark and print area to find the print start position.

### **Cut mode**

A printer mode where an optional cutter module is installed to automatically cut media from the supply roll after they are printed. The print command can specify to cut after every print or to cut after a set number of prints.

### **Cutter module**

A device used to cut the media.

### **DHCP**

Dynamic Host Configuration Protocol

A communications protocol that allocates an IP address to a computer plugged into a network.

### **DPI**

Dots Per Inch

The unit used to express print density.

### **Expansion I/O interface**

An interface circuit that may be installed to allow the printer to be connected to an external device such as a wrapping machine. It can receive feed, print start, and pause signals from the external device and to send back print, pause, and error status signals to the external device.

### **Feed gap sensor**

A transmissive sensor that detects the difference of potential between the gap between labels and the label to find the print start position.

### **Font**

A complete set of alphanumeric characters in one style of type. E.g. Helvetica, Courier, Times

### **Gap**

Gap between labels on a backing material

### **IPS**

Inch per second

The unit used to express print speed.

### **Label**

A type of media with adhesive backing.

### **LCD**

Liquid Crystal Display

Installed on the operation panel and displays operation modes, error message etc.

### **Media**

Material on which data is printed by the printer. Labels, tag paper, fanfold paper, perforated paper etc.

### **Plug and Play**

When Plug and Play is enabled, the PC will automatically identify the printer (if the PC supports Plug & Play), optimise the system resource (IRQ and DMA), and display a message prompting a printer driver installation.

### **Pre-printed media**

A type of media on which characters, logos, and other designs have been already printed.

**Printer IP address**

A 32-bit address of a printer connected to TCP/IP network, which identifies the printer. An IP address is written as 4 sets of numbers, separated by full stops. For example 192.168.10.20.

**Print head element**

The thermal print head consists of a single line of tiny resistive elements. When current is allowed to flow through each element it heats up causing a small dot to be burned onto thermal paper or a small dot of ink to be transferred from a thermal ribbon.

**Print speed**

The speed at which printing occurs. This speed is expressed in units of IPS (inches per second).

**Reflective sensor**

See Black mark sensor.

**Resolution**

The number of individual dots a printer can produce within a unit of distance. Printer resolution measured in Dots per Inch. As the number of dots per inch increases, the resolution increases, resulting in a more detailed image.

**RFID (Radio Frequency Identification)**

RFID is a technology that uses radio waves to exchange data between a reader and an electronic tag. The tag can be encapsulating inside a label which can also be printed on. RFID is very useful for object identification and tracking.

**Ribbon**

An inked film used to transfer an image or text onto media. In thermal transfer printing, it is heated by the print head, causing an image to be transferred onto the media.

**Strip mode**

The printer removes labels from the backing paper. After each issue the printer stops until the label is removed. Once the label is removed the next label will be issued and so on.

**Supplies**

Media and ribbon

**Tag**

A type of media with no adhesive, usually made from cardboard or other durable material.

**Thermal direct printing**

A printing method using no ribbon and thermal media which reacts to heat. The print head makes direct contact with the media producing text or images.

**Thermal print head**

A print head using thermal transfer or thermal direct printing method.

**Thermal transfer printing**

A printing method where the thermal print head heats an ink or resin coated ribbon against the media. The ink/resin is then transferred onto the media.

**Threshold setting**

A sensor setting that allows the printer to maintain a consistent print position of pre-printed media.

**Transmissive sensor**

See Feed gap sensor.

**USB (Universal Serial Bus)**

An interface that is used to connect peripherals, such as a printer, keyboard, mouse to computer or host. The USB port may allow disconnection of a USB device without turning off the power.

**Web printer**

The web printer function allows you to browse the printer status on the PC, issue media, check or change the settings, or download firmware to the printer. For details, refer to the **Network Specification**.



**TOSHIBA TEC CORPORATION**

**E** EO1-33107

© 2015, 2016 TOSHIBA TEC CORPORATION All Rights Reserved  
1-11-1, Osaki, Shinagawa-ku, Tokyo 141-8562, JAPAN